

Investigation of correlation of the vari  
AC .H3 no.L71 15394



Lee, Jong Hae  
SOEST Library

FEB 13 1989

RETURN TO  
HAWAII INSTITUTE OF GEOPHYSICS  
LIBRARY ROOM

INVESTIGATION OF CORRELATION OF THE VARIATIONS  
IN HYDROGEN AND HELIUM COMPOSITIONS IN THE  
GASES FROM FUMARoles WITH ERUPTIONS  
IN ASSOCIATED VOLCANOES

A THESIS SUBMITTED TO THE GRADUATE DIVISION OF THE  
UNIVERSITY OF HAWAII IN PARTIAL FULFILLMENT  
OF THE REQUIREMENTS FOR THE DEGREE OF

MASTER OF SCIENCE

IN CHEMISTRY

MAY 1971

By

Jong Hae Lee

Thesis Committee:

John J. Naughton, Chairman  
Harry Zeitlin  
Robert W. Buddemeier

## ACKNOWLEDGEMENTS

Assistance has been given for this research by many people to whom I wish to express grateful acknowledgement. In particular, I would like to thank Dr. Guy Dority for the help in sample collecting, and Dr. James B. Finlayson for his help in the construction of the gas chromatographic system. Many thanks are due the staffs of the U. S. Geological Survey in the Hawaiian Volcano Observatory for their efforts to help with the on-the-site investigation. Finally, I am grateful to the National Science Foundation (NSF) for the grants for this research.

## TABLE OF CONTENTS

	Page
ACKNOWLEDGEMENTS . . . . .	iii
LIST OF TABLES . . . . .	vi
LIST OF FIGURES . . . . .	vii
I. INTRODUCTION . . . . .	1
A. Volcanology . . . . .	1
B. Volcanic Gases and Their Role in Eruptive Phenomenon . . . . .	7
C. Statement of the Problem . . . . .	9
D. Review of Previous Literature . . . . .	10
II. EXPERIMENTAL WORK . . . . .	22
A. Collection of Gas Samples . . . . .	22
1. Gas Collecting Tube . . . . .	23
2. Gas Collection Techniques . . . . .	27
B. Gas Analysis System . . . . .	29
1. Principle of Gas Chromatography . . . . .	31
2. Description of the Analysis System . . . . .	34
3. Operating Procedure . . . . .	44
III. RESULTS AND DISCUSSION . . . . .	50
A. Introduction . . . . .	50
B. Evaluation of Experimental Technique . . . . .	51
1. Evaluation of the Samples . . . . .	51

	Page
2. Evaluation of the Sampling Tube . . . . .	57
3. Source of Errors in Analysis . . . . .	61
C. Interpretation of the Results . . . . .	63
IV. CONCLUSION . . . . .	71
A. Regarding the Experimental Techniques Employed for Collection and Analysis of the Gas Samples . . . . .	71
B. With Regard to the Gas Analyzing System . .	72
V. SUMMARY . . . . .	73
APPENDIX I . . . . .	74
BIBLIOGRAPHY . . . . .	77

## LIST OF TABLES

	Page
I. CALIBRATION OF THE THERMAL CONDUCTIVITY DETECTOR	40
II. PARAMETERS OF THE GAS CHROMATOGRAPHIC SYSTEM . .	49
III. ANALYSES OF SULFUR BANK SAMPLES . . . . .	52
IV. MOLE PERCENTS OF THE SAMPLES AFTER AIR CORRECTIONS . . . . .	54
V. PRECISION AND ACCURACY OF THE GAS ANALYSIS SYSTEM . . . . .	60

## LIST OF FIGURES

	Page
1. Schematic Diagram of Sampling Tube . . . . .	25
2. Gas Analysis System: Extraction and Measurement Section . . . . .	35
3. Gas Chromatographic System . . . . .	36
4. Extraction and Measurement System for CO <sub>2</sub> . . . . .	47
5. H <sub>2</sub> and He Variations with Time at the Sulfur Bank Fumarole . . . . .	65
6. Mole Ratios of H <sub>2</sub> and He to H <sub>2</sub> O with Time at the Sulfur Bank Fumarole . . . . .	66

## I. INTRODUCTION

### A. Volcanology

A volcano may be defined as a vent or mountain where molten rock or magma and volatiles issue at the surface of the earth. About 500 volcanoes are known to be active today, and all are located on or near the major fault systems of the earth's crust. Volcanology is a very old science. Pliny the Elder, the great Roman natural historian, lost his life during the great eruption of Vesuvius in 79 A.D. A lot of information has been collected on the physical nature of lavas and the structure of volcanic mountains, but until recently interpretations of these facts have mostly been descriptive. Only after about 1920 has the emphasis in volcanology shifted to an experimental approach with the interpretations based on the theories of physics and chemistry.<sup>1</sup>

In order to understand volcanic phenomena it is, first of all, necessary to know where the magma originates and how it is formed. It is believed that the earth's crust is a thin shell about 20 to 60 kilometers thick in continental areas and as little as 3 kilometers thick beneath the oceans. Beneath the crust lies the mantle which extends to



the boundary of the core at a depth of 2900 kilometers. The magma that erupts at volcanoes is generally believed to be originated in the upper part of the mantle.

In recent years, it has been recognized by seismologists that the earthquakes in Hawaii stem from a zone about 40-60 km. deep beneath the active volcanoes. This corresponds to a depth of 35-50 km. below the top of the mantle in that region. Eaton and Maruta<sup>2</sup> estimated that to raise lava to the summit of Kilauea (1.2 km. above sea level) the column of lava must extend to a depth of at least 39 km. below sea level; and to raise lava to the summit of Mauna Loa (4.2 km. above sea level), it must extend to a depth of at least 57 km. They obtained these figures by balancing the average densities of the lava column and the earth's crust. Seismographs at Kamchatkan volcanoes also suggests that the magma is formed at a depth of 50 to 60 km. corresponding to the outer region of the mantle. In view of the facts mentioned so far, it can be assumed that Hawaiian magma originates at about 40 km. deep below the volcanoes.

It is impossible to know an exact temperature within the earth, since no direct measurement is available. However, recent estimates place the temperature at a depth

of 100 km. at about  $1200^{\circ}$  C and at 200 km., about  $1500^{\circ}$  C. These estimates are, of course, considered as general averages, and deviation from them is to be expected locally. According to recent estimates by Verhoogen, the temperature in the upper region of the mantle is above the melting point of basaltic lava ( $1400-1500^{\circ}$  C) under surface conditions.<sup>3</sup> However, seismological evidence indicates that the earth is essentially solid down to the boundary of the core. This seems to be reasonable because the solidity of the mantle is the result of the increase in melting temperature with increasing pressure. At a depth of 200 km. the possible melting point of the basaltic lava is about  $100^{\circ}$  C lower than the approximate temperature at which basalt would become completely molten, according to Verhoogen. It would appear in this case that either a small rise in temperature or reduction of melting point through lowering of pressure or introduction of fluxes might result in melting and formation of magma.

The temperature at 60 km. depth, following the normal increase of temperature with depth in the earth, does not even approach the surface melting point of basalt. Therefore, it seems that a local rise in temperature is needed

for the formation of molten magma. There must be several sources that can supply heat for such rise in temperature. Combustion of volcanic gases, and liberation of latent heat of crystallization might be the sources among others. It turns out that these are minor factors.<sup>4</sup> At present, the origin of heat is not clearly understood.

The composition of the melts reaching the surface of the volcanic areas is very different from the composition generally attributed to the mantle material. The most abundant volcanic rock is basalt. For instance, the major rock composing Hawaiian volcanic mountains is tholeiitic basalt which mainly consists of silica (about 50 weight per cent), aluminum, iron, magnesium, and calcium. Most geologists and geophysicists consider that the outer part of the mantle consists of a rock known as peridotite containing large amounts of olivine, iron, and magnesium. C. S. Ross et al.<sup>5</sup> among others have insisted that fragments of peridotite brought to the surface in rising lava represent mantle rock. However, we cannot say with certainty that any sample has come from the mantle.

If basalt magma originates from the melting of peridotite, the melting is incomplete. No single melting point can be

expected because peridotite is composed of several different minerals which have different melting points. At temperatures within the melting range, the constituents with lower melting points melt earlier than those with higher melting points. Then the liquid portion can be removed from the remaining solid, and it will have a composition different from that of the total original solid. Basalt magma may be formed from peridotite in that way.

When magma enters the deep conduit beneath the volcano, it starts ascending at relatively slow rate through the heated depths towards the cooler crust and volcanic pile above. After leaving the upper part of the mantle and traversing the basaltic layer, the magma emerges into the lighter, weaker rocks composing the volcanic pile and finally collects into a chamber only about 5 km. beneath the surface. The chamber swells and shrinks as it is filled with lava or empties during eruptions. These processes cause the mountaintop to move up and down, and swelling may continue for months or even years before an eruption. The swelling and shrinking of the mountain are measured by tiltmeters. An increase in pressure due to inflation of the chamber drives the molten magma into the dikes that split the solid crust

above the chamber. When one of these dikes breaks through to the surface, an eruption takes place. The consequent decrease in pressure produces deflation of the chamber as lava is discharged. Occasionally, magma from the main chamber is driven into the mobile core of "rift zone," a fractured belt on flanks of volcanoes. This phenomenon causes a flank eruption to take place, sometimes miles from the summit of the volcano.

Rapid deflation of the central chamber into the rift zone can lead to the collapse of the ground surface by withdrawal of support from below. This process seems to be responsible for the formation of pit craters and calderas.<sup>2</sup>

Hawaiian volcanoes are built by numerous outpourings of fluid basaltic lava with very little accompanying explosive activity. Such eruptions give rise to broad rounded mountains known as shield volcanoes. For instance, Mauna Loa and Kilauea are shield-type volcanoes, which extend in two directions from their summit calderas at an angle of approximately 135 degrees.<sup>6</sup> These eruptions are fed principally by magma rising through cracks in the volcanic edifice, and the cracks are concentrated in the rift zones. The rift zones, which consist of hundreds of closely spaced thin

dikes, extend radially outward from the apex of the mountain. Eruptions through rifts occur frequently. Such eruptions are called "fissure" eruptions. On the other hand, continental volcanoes such as Mt. Shasta in California and Fuji-san in Japan are primarily built by eruptions from a central pipelike conduit. They have many dikes and occasionally erupt on flank areas, but eruptions from the central vent are predominant. Explosive activity is more common than for Hawaiian volcanoes. The greater explosiveness of these volcanoes is presumably the result of greater viscosity of the erupting magma and a greater amount of gas in the magma. Why these volcanoes have a central pipe conduit, instead of the fissure-type conduits of shield volcanoes, is not clearly understood.

#### B. Volcanic gases and their role in eruptive phenomenon

Volcanic gases are the volatiles dissolved in the magma. As the lava stored in the high-pressure chamber reaches the surface, these gases are released. Rapid liberation of the gases sometimes produces the spectacular lava fountains, and even the violent explosions common to some volcanoes. The volcanic gases, which generally contain water as a chief

component (more than 75 volume per cent), also include carbon dioxide, carbon monoxide, sulfur gases, chlorine, hydrogen chloride and ammonium chloride, and in lesser abundance hydrogen, helium, argon, methane, oxygen and nitrogen. All of these gases are not always present, and their relative amounts change considerably.

It has been suggested by some investigators that the change in composition of certain gases issuing from volcanic vents and fumaroles could be used to indicate the approach of an eruption. Heald et al.<sup>7</sup> found some evidence that concentrations of the sulfur gases, from Sulfur Bank at Kilauea Volcano, increased significantly preceding and during the eruptions. Noguchi and Kamiya<sup>8</sup> reported that an impending eruption could be predicted by measuring the changes in total sulfur and chlorine from an active crater. The amounts of these two gases collected at Asama volcano in Japan increased remarkably before the eruptions, but considerably decreased just after the eruptions. Similarly, after investigating the gases sampled at Ebeko volcano, Surnina et al.<sup>9</sup> found an abrupt increase in haloid constituents of fumarole gases before the eruptions.

### C. Statement of the problem

Since Finlayson<sup>10</sup> reported the results of his analysis of fumarolic gases collected at Sulfur Bank, which is probably associated with the volcano Kilauea, attention has been drawn as to the presence of hydrogen and helium in these gases. Also there is an indication that they may vary significantly in composition before and after the eruptions. However, no conclusive evidence has been shown as to the relationship between an eruption cycle and the variations of these two gases.

It was suggested that a consistent and thorough investigation of these gases might provide an indication of an eruption in advance of its onset. The purpose of this research was to analyze the fumarolic gases issuing at the Sulfur Bank fumarole on a weekly or biweekly basis, to investigate the changes in hydrogen and helium in relation to the eruption cycle, and perhaps pave the way to the prediction of volcanic eruption by this method.

It is evident that if this phenomenon is found to be a general one, it would be extremely important in monitoring volcanoes for indications of the approach of eruptions, particularly in regions where these events can be catastrophic.



If simple, inexpensive detectors for these gases can be developed, they might have wide application in remote or underdeveloped areas where many volcanoes are located.

As an approach to this problem, it seemed desirable first of all to modify sampling devices for the principal gases, based on existing designs and methods. A gas analysis system based on gas chromatography was to be used. It was hoped that this investigation would then provide us with more knowledge of the relationships of volcanic gases to the eruptive cycle occurring at the Hawaiian volcanoes.

#### D. Review of previous literature

Early studies on volatile materials emanating from volcanoes were made in the middle of the nineteenth century, but relatively little attention has been given to the volatiles in comparison with that directed to the solid phases. This is due more to difficulties involved with collecting and analyzing reliable samples than to lack of interest. Thus, the early work was mostly qualitative in nature.

In 1912, Day and Shepherd<sup>11</sup> collected gas samples from cracks in a dome of lava built up over a lava fountain on

the floor of Halemaumau in Hawaii. Analysis of these samples showed a range of 11 to 60 volume percent nitrogen and air in the collected gases. Also the iron intake pipe that was employed for sampling the gases was badly corroded in this investigation. It seemed that the corrosion of the iron pipe was probably due to the reaction, especially in the presence of air contamination. Thus the primary composition of the gases collected might be altered by this factor.

During the period 1917-1919, Jagger and Shepherd<sup>12</sup> took advantage of excellent sampling conditions created in the Halemaumau crater of Kilauea volcano. The gases collected during that time were analyzed by Shepherd, who found hydrogen, argon, nitrogen, carbon dioxide, carbon monoxide, sulfur, sulfur dioxide, sulfur trioxide and water in the samples. The amount of air in the collected gases showed a range of 0 to 100 percent. Shepherd assumed that oxygen found in the samples was due to atmospheric contamination. Hence he subtracted corresponding atmospheric quantities of nitrogen, carbon dioxide and water from his analysis results.

Allen<sup>13</sup> sampled gases from the steam well of Sulfur Bank at Kilauea volcano. He determined sulfur, sulfur

dioxide and the ratio of water to the remaining gases. For these three determinations it was necessary to take three separate samples. For sulfur vapor collection, a glass intake led the gases into a series of two small bottles. The gases were pulled through the bottles by a gas aspirator. A measured amount of water was added to each bottle, and the first bottle was kept in an ice-water bath so that most of the water vapor could be condensed there. When 10 liters of gas had been pulled through the bottles, the condensed water vapor and precipitated sulfur were determined as a ratio of sulfur vapor to water vapor. Sulfur dioxide was collected in the bottle containing 20 percent NaOH, and was determined by precipitating it from this solution as  $\text{BaSO}_4$ . The remaining components, water vapor and "fixed" gases were determined by measuring the volume of the fixed gases that accompanied a measured amount of condensed water vapor.

The fixed gases were kept in the bulb for later analysis which was not reported. Permanent gases such as helium and argon as well as hydrogen might have been detected, if the gases had been carefully analyzed in this investigation.

From 1927 through 1929, Grange<sup>14</sup> sampled fumarolic gases from the crater of White Island, one of the most active volcanic areas in New Zealand. In 1927, samples were collected by placing a gas bottle with a small funnel attached in the vent. When the air was judged to be displaced, the bottle was removed and sealed. These samples were badly contaminated with air (more than 85 percent). The analysis of these gases showed  $\text{SO}_2$ ,  $\text{HCl}$ ,  $\text{CO}_2$ , but no  $\text{H}_2$  and  $\text{H}_2\text{S}$  were found. The rest of the samples were obtained by liquid displacement method. The gas was led from the fumarole vent through narrow-diameter copper tubing to a sampling bottle filled with mercury or water. Air content in these samples was considerably decreased. The highest air concentration was 19.1 percent and the lowest zero percent. Grange observed a large amount of  $\text{H}_2$  (greater than 20 percent of air free gases) in the samples taken by the liquid displacement method. The unusually large amount of  $\text{H}_2$  would probably come from the reaction between the copper inlet tube and the acid gases such as  $\text{H}_2\text{S}$  and  $\text{HCl}$ .

The fumarolic gases were further investigated by Stephen<sup>15</sup> in the Netherlands, Ivanov in Russia,<sup>16</sup> and

Phillips at Mt. Hood, Oregon.<sup>17</sup> But no samples were collected specially to obtain reliable quantitative measurements.

Ballard and Payne<sup>18</sup> took fumarolic gases from the Sulfur Bank during a period of 1938 to 1940. Their primary purpose was to observe any correlation between volcanic cycle and variations in the composition of the gases, particularly sulfur dioxide. The samples contained CO<sub>2</sub>, SO<sub>2</sub>, air, small amounts of O<sub>2</sub> and N<sub>2</sub>, and trace amount of air. In an attempt to find any regularity about the variations in gas composition, the workers figured out the volume percentage of the chief components, CO<sub>2</sub>, SO<sub>2</sub> and air as well as the ratios of SO<sub>2</sub> to CO<sub>2</sub>. The results, however, indicated that there appeared to be no regularity about the variations in relation to the eruption activity.

One of the difficulties in studying volcanic gases has been the reactions between the gases after collections. Fabre and Chaigneau were the first investigators who suspected these kinds of reactions. In order to collect fumarolic gases at Mount Pele and Grande Soufriere in the West Indies, they prepared three bulbs which were evacuated to about  $10^{-2}$  mm Hg before sealing. In one bulb, they packed an excess

amount of powdered  $P_2O_5$  so that all water vapor could be removed from the gas mixture during collection. The second bulb was a weighed tube of  $P_2O_5$  absorbed on pumice. With these two bulbs the amount of water vapor in the sample could be measured. The third bulb contained no  $P_2O_5$  so that a comparison of the effect of interactions during collection on the gas composition could be made with the first two bulbs. The results showed that the use of  $P_2O_5$  was quite efficient in preventing the reaction between  $SO_2$  and  $H_2S$ . Furthermore,  $CO_2$ ,  $O_2$ ,  $CH_4$ ,  $N_2$  and rare gases, which were found in the analyses, were not affected by the dessicant.

In later collections, these workers replaced the dessicant,  $P_2O_5$  by  $CaC_2$  to determine the water content in the gases. The amount of water absorbed in the dessicant could be determined by measuring the volume of  $C_2H_2$  from the reaction equation:

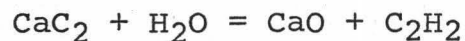

They observed that both methods gave the same composition, and the  $CaC_2$  seemed to react with water vapor more efficiently than  $P_2O_5$ .<sup>19</sup>

Recent studies of the gases from Japanese volcanoes were made by several research groups in Japan.<sup>20, 21, 22</sup> Noguchi and Kamiya,<sup>8</sup> among others, considered if volcanic eruption could be predicted by the measurement of gases emanating from active craters. They developed a sampling device which could be used for this purpose. Their device was a small glass dish containing 500 ml of 25 percent KOH solution which absorbs acidic gases. This dish was placed in a wooden box whose sides were full of holes to allow gases to enter. Several of these boxes were set up at the edge of the active crater and a sulfataric zone being investigated. The workers changed the KOH solution every 7 to 10 days and analyzed CO<sub>2</sub>, total sulfur, and total chlorine. From the observation of the variations in sulfur and chlorine contents they concluded that the time of an approaching eruption could be predicted by this method.

In most recent years the development of powerful analytical techniques such as gas chromatography has provided methods of gas analysis of greater scope and sensitivity.

Naughton et al.<sup>23</sup> were one of the research groups which employed gas chromatographic technique for the analysis

of volcanic gases. During 1959-1960 Kilauea eruption they collected gas samples by using a Pyrex glass tube. In an attempt to prevent interactions among gases during and after collection, they packed in the sampling tube 20 to 60 mesh absorbent particles of silica gel. The silica gel-packed tube was baked at  $350^{\circ}$  C under vacuum to activate the absorbent before collection. This sampling device was found to be one of the most efficient ones ever employed.

Naughton and co-workers observed in this investigation that by using the absorbent silica gel they could separate the lighter gases ( $H_2$ ,  $N_2$ ,  $O_2$ , etc.) from the heavier gases ( $CO_2$ ,  $SO_2$ ,  $H_2S$ , etc.). The heavier gases were absorbed on the silica gel and showed no tendency to remix even when kept for long periods after collection. They used five chromatographic columns for a complete separation of the sampled gases. The lighter gases ( $H_2$ ,  $O_2$ ,  $N_2$ ,  $CH_4$  and  $CO$ ), which were kept in the free volume of the tube, were analyzed with a molecular sieve 5A column, using Ar as a carrier gas at  $125^{\circ}$  C. Another molecular sieve 5A column was used to separate Ar and  $O_2$  at  $-78^{\circ}$  C with He carrier gas. A third column, which was packed with silica gel and cupric oxide, determined  $CO_2$  and  $CO$  at  $125^{\circ}$  C. A column



of tricresyl phosphate on C-22 firebrick was used to separate  $H_2S$ ,  $CO_2$  and  $SO_2$  at  $0^\circ C$ , and a distillation trap with silica glass to separate  $CO_2$ ,  $SO_2$  and  $CS_2$  at  $-196^\circ C$ . All columns except the first were run with He carrier gas. Using air samples, they determined the accuracy and precision of the equipment (about 3.5 percent deviation) prior to the actual analysis of the samples. A thermal conductivity gas detector was used throughout.

Suwa in Japan<sup>24</sup> employed a gas chromatographic method to analyze "residual gases" taken from the fumaroles at several volcanoes. The sample gases were collected using a silica gel-packed glass tube, and washed with a concentrated alkali solution so that the residual gases could remain as a gas phase. These gases ( $H_2$ ,  $N_2$ ,  $O_2$ ,  $CH_4$ ,  $CO$  and rare gases) were kept in a glass tube for analysis.

She separated the six components in the gases with Ar carrier gas, using columns of molecular sieves 5A and 13X. Oxygen was used as carrier gas when she determined Ar (oxygen in the sample was previously removed with a catalyzer in this case). Suwa found that the molecular sieves 5A column gave better resolution than the 13X column. Helium was also detected by eliminating  $H_2$  through a palladium leak.

A recent investigation of hydrothermal emanations at Yellowstone National Park was made by Gunter and Musgrave<sup>25</sup> using gas chromatographic technique. They used two columns and a thermal conductivity detector for the complete analysis of the emanations. With their system they determined CO<sub>2</sub>, H<sub>2</sub>, H<sub>2</sub>S, O<sub>2</sub> + Ar, N<sub>2</sub>, CH<sub>4</sub>, CO, and SO<sub>2</sub> with one run of the sample through the gas chromatograph. CO<sub>2</sub>, H<sub>2</sub>S, and SO<sub>2</sub> were separated with a 25 percent sulfolane on firebrick column, which produced a "composite" peak for the other gases. A molecular sieve 13X column was used to analyze the composite gases, while the H<sub>2</sub>S, SO<sub>2</sub> and CO<sub>2</sub> were irreversibly absorbed on this column. As the composite gases were eluded from the 13X column, they were detected at the reference side of the detector. A polarity switch was needed to obtain positive recorder peaks for these gases. In order to separate Ar from O<sub>2</sub>, they replaced the 13X with a molecular sieve 5A column which was operated at -9° C. They periodically monitored the reliability of their equipment by checking retention times of the gases and by comparing the total number of moles of gas observed in each sample with the number of moles expected from the sample volume, pressure, and temperature. They found that the

observed number of moles agreed within 3 percent on the average with the calculated number of moles which indicated satisfactory behavior of their system. However, it should be noted that the irreversible absorption of CO<sub>2</sub>, H<sub>2</sub>S and SO<sub>2</sub> on the 13X column decreased the separating ability of this column for the other gases. It was necessary, in their study, that the 13X column be reactivated or replaced frequently.

An intensive study of Hawaiian volcanic gases was made by Finlayson<sup>26</sup> in 1967. The sampling devices and technique for this research were similar in principle to those developed by Naughton et al.<sup>23</sup> except that the sampling tube was placed inside a protective quartz shield which was filled with crushed firebrick.

A gas chromatographic technique was employed for the analysis of the gases. "Permanent gases" (He, H<sub>2</sub>, N<sub>2</sub>, O<sub>2</sub>, CH<sub>4</sub> and CO) were separated on a 60 to 80 mesh of molecular sieve 5A column. At -78° C and with Ar carrier gas separation was achieved for He and H<sub>2</sub> among the permanent gases. At the same temperature, but with He carrier gas Ar and O<sub>2</sub> were determined. The column also separated H<sub>2</sub>, O<sub>2</sub>, N<sub>2</sub>, CH<sub>4</sub> and CO with He as the carrier gas at room temperature.

"Condensable gases" including water, which were absorbed on the silica gel in the tube, were removed by slowly raising the temperature by means of an asbestos furnace and heating tapes. An 80 to 100 mesh silica gel column was used to determine the condensable gases (air,  $\text{CO}_2$ ,  $\text{COS}$ ,  $\text{H}_2\text{S}$ ,  $\text{CS}_2$  and  $\text{SO}_2$ ). In order to measure the amount of water a removable glass trap was set up between the sampling tube and the chromatographic system. This trap was cooled with dry-ice and acetone to condense the water vapor liberating from the sample tube. The molecular sieve 5A column was reactivated by heating at a temperature of  $360^\circ\text{C}$  for several hours whenever the separating ability of this column deteriorated.

With the results obtained, Finlayson examined the variations in the  $\text{H}_2\text{S}$  and  $\text{SO}_2$  compositions, and the ratios of hydrogen and sulfur to carbon dioxide in relation to the time of eruption. However, the conclusion was reached that none of them seemed to be related to the eruption cycle.

## II. EXPERIMENTAL WORK

### A. Collection of gas samples

The design of volcanic gas collection, ideally, must meet three requirements if the sample is to be representative of the gases. First, the sample should be free from any possible contamination by air. It is very difficult to meet this requirement because sampling sites for volcanic gases are hot and surrounded by atmospheric air and suffocating gases issuing from the sampling sites. This difficulty is often compounded by the inaccessibility of sampling sites due to the volcanic activities. Secondly, the collected gases must not be allowed to react among themselves in the sampling device. As mentioned previously, powdered  $P_2O_5$  and  $CaC_2$  were used by Fabre and Chaigneau<sup>19</sup> and silica gel by Naughton<sup>23</sup> in order to prevent interactions among the gases, especially water vapor,  $SO_2$  and  $H_2S$ . Having been proved to be fairly efficient, these three absorbents have so far been used for the collection of volcanic gases. Finally, the sampling device must not be affected by the corrosive nature of the gases after the collection. It is true that if the device gets corroded, the primary composition of the gases would be changed.

A survey of the literature shows that five basic methods have been employed for collecting volcanic gas samples: displacement of air from the sample container, displacement of water or mercury, vacuum tubes, condensation, and absorption. By far, the most popular method has been the displacement of air in the collecting device with the volcanic gases.

1. Gas collecting tube

The gas collecting tube used in this research was based on the combination of an absorption and vacuum sampling tube. The main feature of the design was the construction of a free volume which could collect a large amount of the residual permanent gases including hydrogen and helium, and the inclusion of two kinds of commercial absorbents, Aquasorb and Mallcosorb, for the prevention of interactions among the gases during and after collections. Water vapor or condensed water entering the collecting tube could be immediately absorbed in the Aquasorb, and the condensable acid gases ( $\text{CO}_2$ ,  $\text{SO}_2$ ,  $\text{H}_2\text{S}$ , etc.) were absorbed into the Mallcosorb.

The sampling tube illustrated in Figure 1 was constructed as follows:

A piece of Pyrex glass tubing, 20 mm in outside diameter and 30 cm in length (A) was joined to a 15 cm length of 10 mm O.D. (outside diameter) glass tubing with a needle valve of 4 mm in diameter (B) to form the main body of the tube. Another piece of glass tubing with needle valve (dia., 1 1/4 mm), which is 15 cm in length and 8 mm, O.D., was sealed near the end of the tubing (B) to displace air from the lead-in tube before collecting the sample. In an attempt to prevent the glass needle valves from being damaged during handling, two pieces of glass rods, 4 mm in diameter and 5 cm in length each, were connected between the glass valves and the main body of the tube. The glass needle valves made by Fischer and Porter Company, Pennsylvania, consist of a needle valve stem with a Teflon stopcock and glass tubings at both ends. The Teflon stopcock seals through the action of two hard rubber o-rings which prevent leakage of the gases collected, or contamination by air.

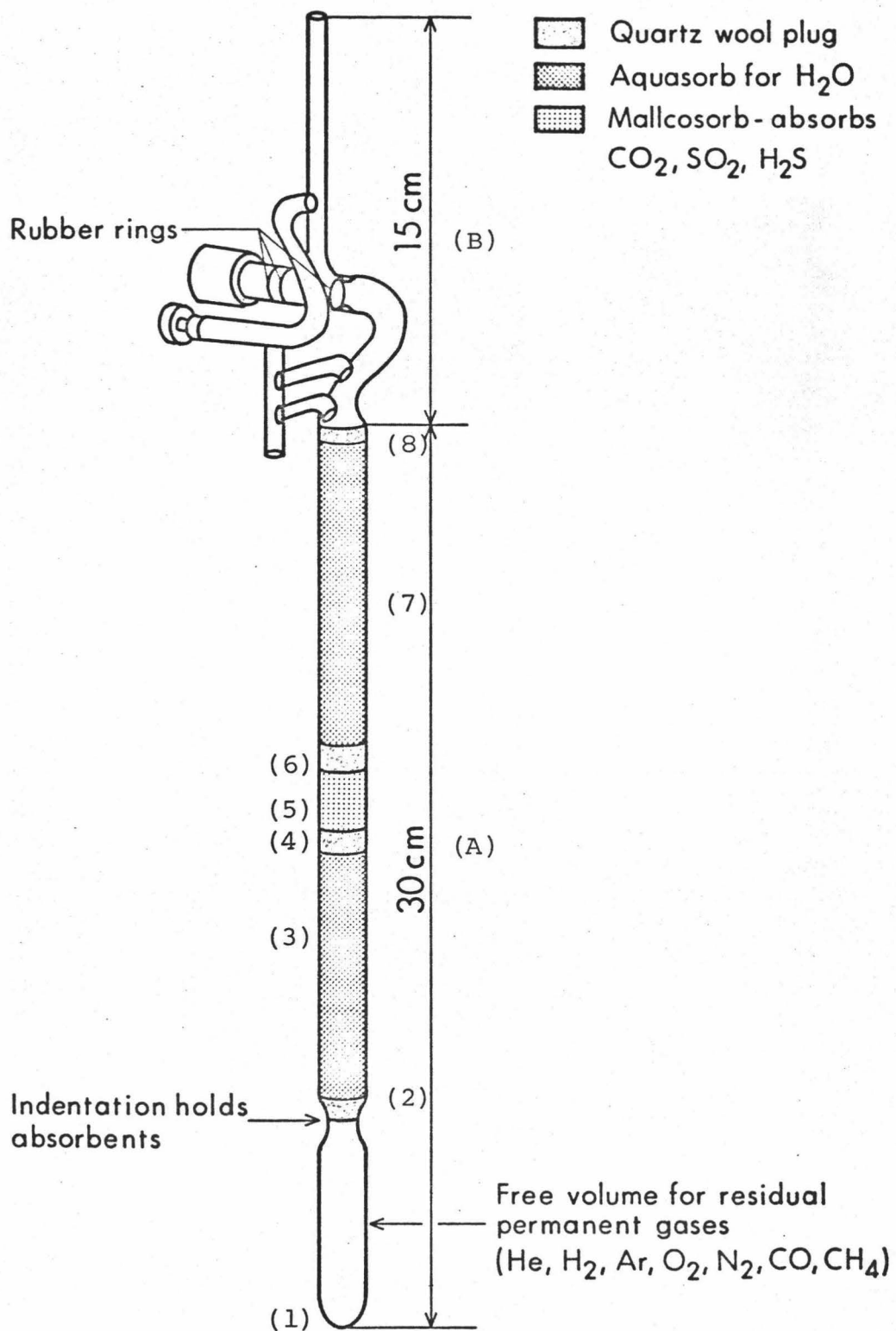

Figure 1. Schematic diagram of sampling tube



The indentation at position (2) was made and a plug of quartz wool was placed in position at (8). Section (7) was then filled with Aquasorb which is a phosphorus pentoxide ( $P_2O_5$ )-based absorbent prepared by Mallinckrodt Chemical Works. Another plug of quartz wool was pushed into position at (6). Then section (5) was packed with about four grams of pink-colored, granular Mallcosorb, a high-capacity absorbent for  $CO_2$ ,  $HCl$ ,  $SO_2$ ,  $H_2S$  and other acidic gases, made also by the Mallinckrodt Chemical Works. The Mallcosorb changes from pink to yellowish tan as it loses absorptivity capacity. Section (3) was also filled with the Aquasorb. The quartz plugs at (4) and (6), together with the ones at (2) and (8), keep those absorbent in place. Finally, the position (1) was sealed by employing conventional glassblowing techniques. The length of the completed sampling tube was about 45 centimeters. A number of sets of these tubes were constructed, for the convenience of packaging and sending the samples from the collecting site to the laboratory.

In order to activate the absorbents, the tube was baked out at approximately 200° C under vacuum condition. This was similar to the method used by Finlayson.<sup>26</sup> The vacuum system consisted of a high vacuum pump manufactured by Welch Duo-Seal Company, two dry ice-acetone traps and an asbestos oven which was able to bake four sampling tubes simultaneously. After being kept for about twelve hours, the sampling tube was removed from the oven under vacuum by closing the main Teflon stopcock that was attached to the tubing (B) (see Figure 1).

## 2. Gas collection techniques

During the course of this investigation all the gas samples were collected from the sulfataric fumarole known as Sulfur Bank, which is situated in the northern rim of Kilauea Caldera. In 1922-1923, Jaggar<sup>27</sup> conducted a boring project at Kilauea volcano to study changes in temperature, gas composition and minerals underground. During that time three holes were drilled at the Sulfur Bank, one 70 feet deep and two on either side 15 feet deep. The deeper hole was cased with

cement and all the three holes were joined at the top by an iron pipe. Since then this iron-piped hole has provided a continuous and reliable source of fumarolic gases for the investigation. Allen<sup>12</sup> was the first investigator who collected and analyzed these gases. Ballard and Payne<sup>18</sup> sampled gases from this source during 1938-1940. In the 1950's, Naughton et al.<sup>23</sup> used these drill hole gases, and Finlayson,<sup>26</sup> in 1967, conducted a study of fumarolic gases from these drill holes.

In order to sample the gases, a double-walled Teflon plastic tube, about one meter in length and 10 mm in diameter, was connected to one end (the main glass valve) of the sampling tube and pushed into the piped hole until the tip of the plastic tubing touched the wall of the pipe. The end of the side glass valve attached to the main body of the tube was connected to a hand pump to pull the gases through the plastic tubing. The gases were pumped out until it was believed that all of the air originally present had been displaced (about 20 pump strokes). The stopcock of the side glass valve was then closed, and afterwards

the main stopcock was opened to let the gases rush into the evacuated tube. Collection was continued from about fifteen minutes to half an hour to fill the sample tube. Filling was indicated by the color change of the absorbents.

Samples were collected twice or three times a month and the collected samples were generally mailed to the laboratory in Honolulu for analysis. Twice in the present work, field trips were made to collect samples, and for an on-the-site survey of volcanic activities. However, most of the collection of samples was carried out by Drs. Naughton, Dority, and Finlayson, to whom we are very grateful.

#### B. Gas analysis system

In the past, the investigators of volcanic gases have mostly employed, for the analysis of their gas samples, the absorption technique developed by Orsat or Hempel.<sup>28</sup> In this technique, the sample is admitted to a gas burette and its volume measured. The gases are then exposed to a pipette containing an absorption reagent specific for one component among the gases. The gas absorbed on the reagent

can be determined by either measurements of the change in volume or conventional precipitation methods.<sup>12</sup> A major disadvantage of this technique is its inapplicability for analyzing the trace components such as helium. Further, it is very laborious and uncertain due to the lack of specificity of the absorption reagents.

Recently, gas chromatography has been one of the most popular methods for the analysis of volcanic gases. This technique owes its popularity to several of its inherent advantages for the analyst:

(1) Its sensitivity is relatively high so that it can be used for trace analysis, especially when measurements are made with selective detectors.

(2) It is distinguished from other instrumental methods by simplicity and reliability of operation of equipment.

(3) The separation of mixtures containing many components is possible.

(4) The results are obtained rapidly and are easy to interpret.

(5) The equipment required has relatively low cost and a long, useful life.

## 1. Principle of gas chromatography

Gas chromatography is a procedure which separates a gaseous mixture by passing a moving gas phase over a stationary solid or liquid phase. The moving gas phase consists of a carrier gas and the gas sample. When the stationary phase is a solid with surface active properties, such as silica gel or alumina,<sup>29</sup> the technique is termed gas-solid absorption chromatography (GSC). If a liquid coated on an inert solid such as diatomaceous earth is used as the stationary phase, the solid serves no active purpose in the chromatographic process but merely provides an inert base of high surface area for the effective distribution of the liquid layer. The technique is then called gas-liquid partition chromatography (GLC). The stationary phase is packed into lengths of metal or glass tubing to form a chromatographic column.

As the sample and carrier gas pass a partition column, the separation process begins. The sample mixture contains components which have different affinities for the stationary phase. The molecules of components which are highly soluble in the stationary

phase (liquid in this case) will tend to dissolve there more readily than those of less soluble components. The distribution of molecules of a particular compound between the two phases will be governed by the partition coefficient of the compound at the column temperature. When molecules of a compound reach a portion of the column, they distribute themselves between the gas and liquid phase according to the partition coefficient and move to establish an equilibrium condition. But the molecules which remain in the gas phase are immediately swept by the carrier gas farther down the column. Absorption columns operate in the similar way but with relative affinities, rather than solubilities, determining the time required for passage of components through the column. The carrier gas continues to pass through the column causing the components of the gas sample to move down the column and eventually to appear in effluent gas, where a detecting device is placed to measure each component as it appears from the column.

One of the most useful detectors is the thermal conductivity detector. It consists of two thermal conductivity cells (reference and sensing side). The

two electrically heated elements in both cells make up two arms of a Wheatstone bridge; the other two are made up of fixed resistors. The heated elements are made of materials chosen for their high thermal coefficient of resistance; that is, small temperature changes will cause their electrical resistance to change markedly. Initially the bridge is balanced before the sample is injected so that only pure carrier gas is contained in both cells. When a sample component reaches the end of the column and enters the reference cell, the resistance change causes an unbalanced condition in the bridge and a voltage drop which may be measured across the bridge. This voltage, which is proportional to the amount of sample component in the cell at that moment, is measured by means of a recording potentiometer which amplifies the millivolt-level signal out of the detector to a level sufficient to drive the recorder pen across the chart scale. The amplitude of the pen, which was zero when the bridge was balanced, will again be proportioned to the sample component concentration in the detector.



## 2. Description of the analysis system

Schematic diagrams of the gas analysis system used in this investigation are shown in Figures 2, 3, and 4. This equipment was primarily constructed by Finlayson,<sup>26</sup> and was modified for use in this work.

### a. The extraction and measurement system

The extraction and measurement system shown in Figure 2 was used to remove the gases from the sampling tube, perform a preliminary separation of the gases, and determine the volume and pressure of the gases. The residual permanent gases (He, H<sub>2</sub>, Ar, O<sub>2</sub>, N<sub>2</sub>, etc.) kept in the free volume of the tube were released by opening the main stopcock of the tube (A). Water was absorbed on the Aquasorb and the condensable gases (mainly CO<sub>2</sub>) were absorbed on the Mallcosorb packed in the sample tube. If any portion of the H<sub>2</sub>O and CO<sub>2</sub> were taken off together with the permanent gases, these were collected in traps, the H<sub>2</sub>O in a U-trap (B) cooled with dry ice and acetone, and the CO<sub>2</sub> in a U-trap (D) cooled with liquid nitrogen. A removable trap (C) was attached to the system

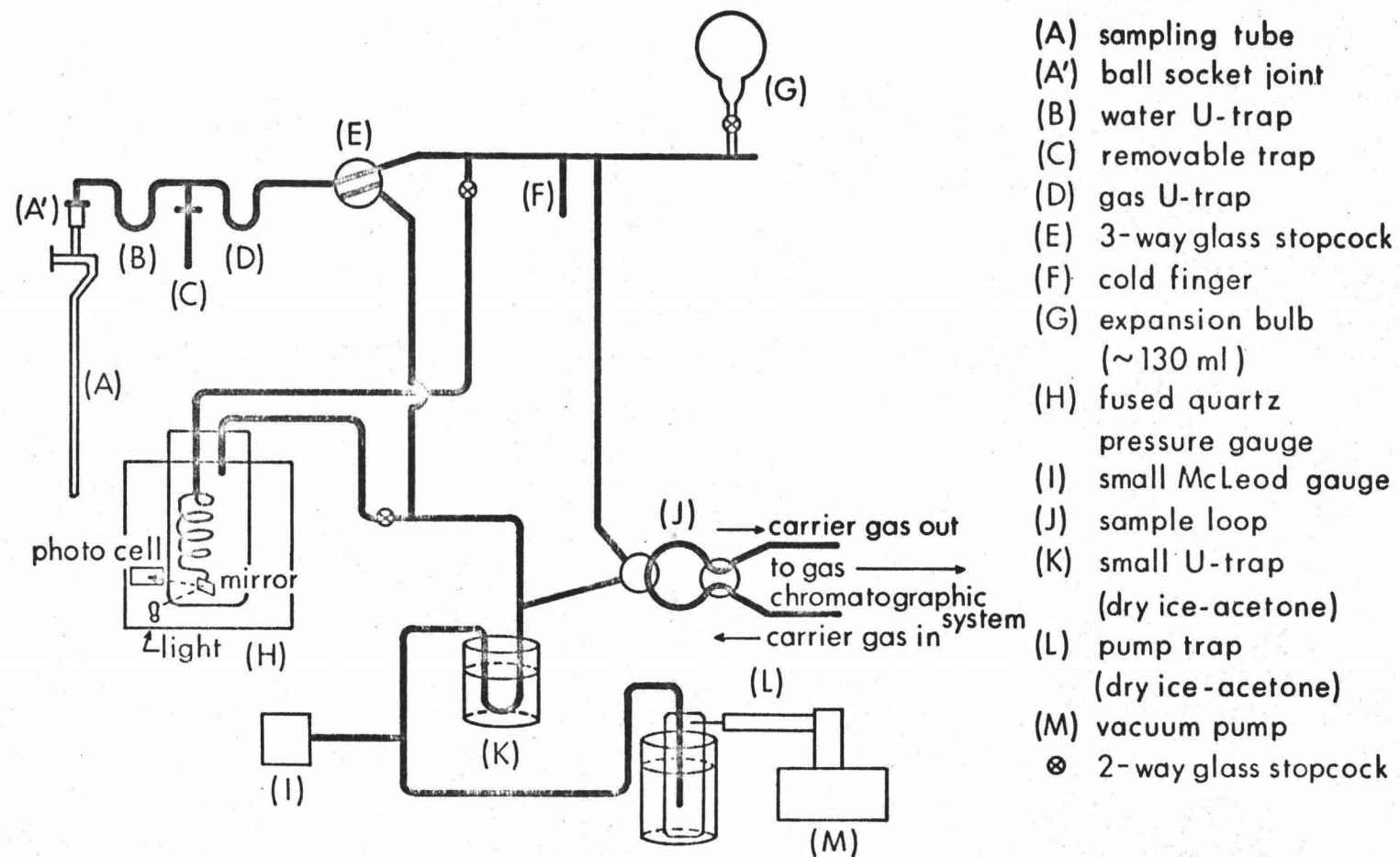

- (A) sampling tube
- (A') ball socket joint
- (B) water U-trap
- (C) removable trap
- (D) gas U-trap
- (E) 3-way glass stopcock
- (F) cold finger
- (G) expansion bulb (~130 ml)
- (H) fused quartz pressure gauge
- (I) small McLeod gauge
- (J) sample loop
- (K) small U-trap (dry ice-acetone)
- (L) pump trap (dry ice-acetone)
- (M) vacuum pump
- ⊗ 2-way glass stopcock

Figure 2. Gas Analysis System: Extraction and Measurement Section

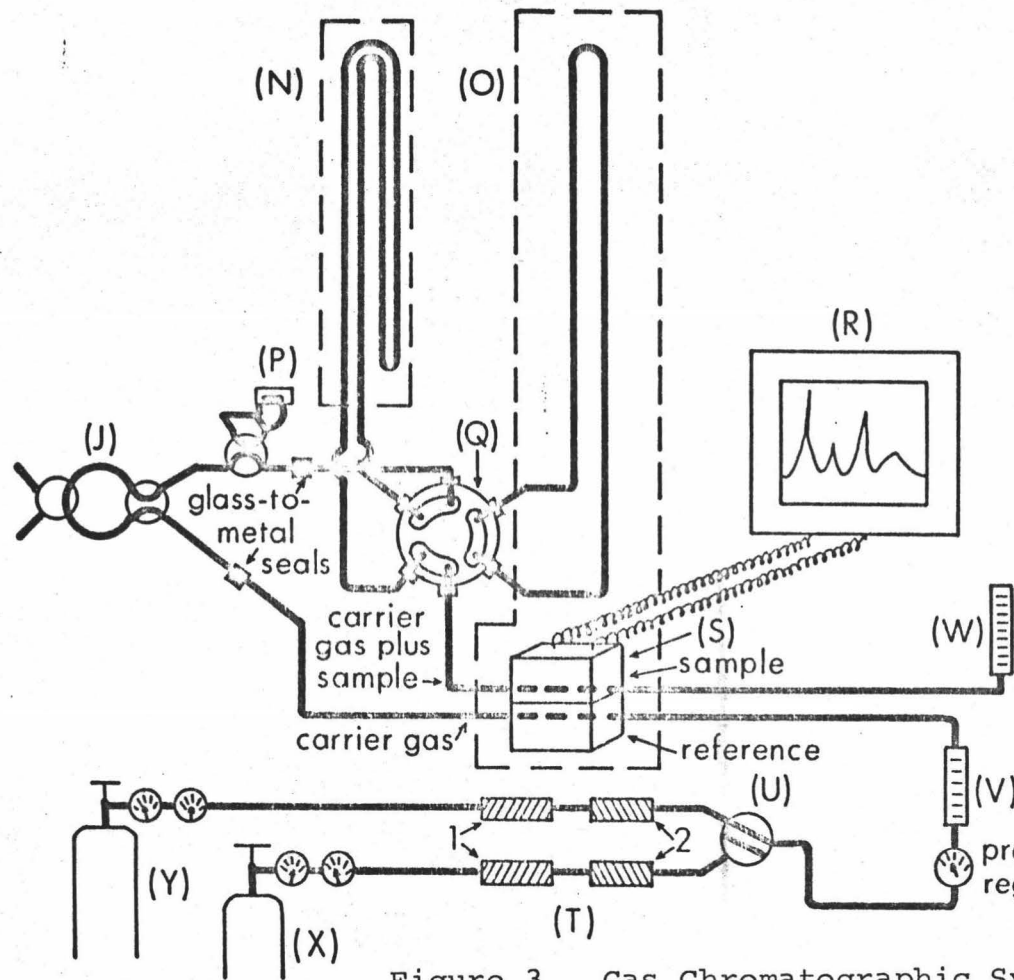

- (J) sample loop
- (N) molecular sieve column & oven
- (O) silica gel column & oven chamber
- (P) injection port
- (Q) Perkin-Elmer 6 way gas valve
- (R) recorder
- (S) thermal conductivity detector block
- (T) desiccant tubes  
1-silica gel  
2-Aquasorb
- (U) 3-way glass stopcock
- (V) flow meter
- (W) soap water flow meter
- (X) argon tank
- (Y) helium tank

Figure 3. Gas Chromatographic System

by means of a ball-and-socket joint in order to remove the H<sub>2</sub>O trapped in (B). A three-way stopcock at (E) was constructed to connect or isolate the extraction system to the left of it and the measuring system to the right, and to provide the extraction system with a direct connection to the vacuum pump (M).

In the measuring section of the system a cold finger served to transfer the condensable gases kept in the U-trap (D) to this section for gas chromatographic analysis. An expansion bulb (G) was set up to determine the volume of the sample tube and the tubing connecting it to the system. If the total pressure of the gases to be analyzed seemed to be greater than one atmosphere, the expansion bulb was utilized to cover the pressure by expanding them into it.

Pressures were measured by a fused quartz precision pressure gauge (H) manufactured by Texas Instruments Company, Houston (Model 140). This gauge consists of a quartz Bourdon tube contained in a capsule and an optical readout system. The

The capsule was designed for use in the range from  $10^{-3}$  mm Hg to one atmosphere, and was calibrated by the manufacturer. Both the Bourdon tube and the readout system could be evacuated by opening the two-way glass stopcocks that connected the pressure gauge to the evacuated measuring section. The readout unit was turned to zero when it was evacuated to the maximum. A McLeod gauge (I) was used to determine the limits of the evacuation (about  $10^{-3}$  torr.). A small U-trap, cooled with dry ice and acetone, prevented mercury vapor from diffusing into the system. The Welch Duo-Seal vacuum pump used in this system was capable of obtaining a vacuum of 0.1 micron, and was separated from the system by the U-trap (L) containing dry ice and acetone.

Samples were introduced into the gas chromatographic system by means of a sample loop (J) formed with two four-way glass stopcocks. The use of the sample loop for sample injection has been described by Jeffery and Kipping.<sup>30</sup>

b. The gas chromatographic system

The laboratory gas chromatograph was equipped as shown in Figure 3. A Gow-Mac Model 9234 thermal conductivity detector (S) was employed to measure the separated gas components in the column effluent. Calibrations of the thermal conductivity detector for the individual gas are summarized in Table I. A home-made D.C. power supply (12 volts) and a Wheelco Series 8000 recorder (R) were used with the thermal conductivity detector. The recorder, with a full scale presentation of one millivolt, was set at a chart speed of 3 minutes per inch. Helium and argon were used as the carrier gases. The recorder was connected to the detector by a Carle Micro Detector Control 1000 which has a range of 1000 to 1, so that both large and small peaks could be recorded on scale. Two absorbent tubes (T), containing silica gel and Aquasorb, were connected between each gas tank, and a three-way glass stopcock (U) was used to select the desired carrier gas. Tank pressure for He carrier gas was set at 30 p.s.i. and 20

TABLE I  
CALIBRATION OF THE THERMAL CONDUCTIVITY DETECTOR

GAS	moles/in <sup>2</sup>	
	Ar Carrier	He Carrier
He	$1.28 \times 10^{-7}$	
H <sub>2</sub>	$8.90 \times 10^{-8}$	
Ar		$5.34 \times 10^{-8}$
O <sub>2</sub>		$7.20 \times 10^{-8}$
N <sub>2</sub>		$6.12 \times 10^{-8}$
CO <sub>2</sub>		$5.72 \times 10^{-8}$
H <sub>2</sub> S		$6.08 \times 10^{-8}$
SO <sub>2</sub>		$4.36 \times 10^{-8}$

p.s.i. for Ar carrier gas. The carrier gas flow rate for each operation was 40 cc per minute. Column head pressure was changed between 5 to 12 p.s.i., depending on the column and column temperature being used. The pressure regulator (V) controlled the column head pressure and the flow rate of the carrier gases. A soap-water flow meter (W) was placed at the detector effluent vent to measure the flow rate. A polarity switch was necessary to reverse the output signal from the detector when Ar carrier gas was used, so that positive peaks were obtained for the separation of He and H<sub>2</sub>, which have greater thermal conductivities than Ar as shown in Table II.

The residual permanent gases (He, H<sub>2</sub>, Ar, O<sub>2</sub>, N<sub>2</sub>, CH<sub>4</sub>, CO) were separated on three sets of molecular sieve 5A column (N). Separation of He and H<sub>2</sub> from the permanent gases was made at -78° C and with Ar as the carrier gas by using a 3/8 inch x 6 foot copper column packed with 60 to 80 mesh molecular sieve number 5A. At the same temperature He was used as the carrier gas for



the analysis of Ar and O<sub>2</sub>. The resolving absorption column for the Ar and O<sub>2</sub> consisted of a copper tubing 1/4 inch x 10 feet filled also with 60 to 80 mesh molecular sieve 5A. A uniform low temperature was obtained by placing the column in a Dewar flask cooled with dry ice and acetone. At room temperature a molecular sieve 5A aluminum column, 5 feet in length and 1/8 inch in outside diameter, separated O<sub>2</sub>, N<sub>2</sub>, CH<sub>4</sub>, CO with He as the carrier gas. Prior to the actual operation these columns were activated by heating at 350° C for several hours while passing the respective carrier gas at a flow rate of 40 cc per minute. Whenever the resolving ability of the column deteriorated it was reactivated by means of an asbestos oven (N) or replaced with a new column.

The separation of these gases under these conditions was reported by Finlayson<sup>26</sup> in his study on Hawaiian volcanic gases. Lard and Horn<sup>30</sup> reported a gas chromatographic separation of Ar, O<sub>2</sub> and N<sub>2</sub> by using a molecular sieve 5A column.

Complete gas chromatographic analysis of fixed gases such as  $H_2$ ,  $O_2$ ,  $N_2$ ,  $CH_4$ ,  $CO$ , and  $CO_2$  was achieved by Manka<sup>31</sup> using a silica gel column in series with a molecular sieve 13X column. The silica gel column served to separate  $CO_2$  and the remaining unresolved gases were separated by the molecular sieve column.

Condensable gases (air,  $CO_2$ ,  $COS$ ,  $H_2S$ ,  $CS_2$ , and  $SO_2$ ) were separated on a 1/4 inch x 2 foot aluminum tube filled with 80-100 mesh silica gel. The column (O) was run at  $100^{\circ}C$  with He carrier gas. The gas chromatographic analysis of these gases was reported by Hodges and Matson<sup>32</sup> using the silica gel column. A Perkin-Elmer six-way gas valve (Q) served to switch either the molecular sieve 5A column or the silica gel column into the flow stream of the carrier gas.

As a preliminary procedure for the actual analysis of the gas samples, the thermal conductivity detector was calibrated by a syringe injection method using a by-pass sample loop (P), which has been described by Jeffery and Kipping.<sup>33</sup>

A calibration gas was injected through the injection port (rubber septum) into the loop by means of a gas-tight syringe, so that the carrier gas could sweep it into the gas chromatographic system.

Air was used for O<sub>2</sub> and N<sub>2</sub> calibration and the other calibration samples were obtained from the gas tanks available in the laboratory. Calibration curves for each gas were made by plotting calculated peak area in square inches against the number of moles injected. The column retention times for each gas are summarized in Table II along with the optimum operating conditions for the gas analyses.

### 3. Operating procedure

Several hours before the operation started, the sample tube was attached to the extraction system. At the same time the molecular sieve 5A column, cooled with dry ice and acetone, was purged with Ar carrier gas at a flow rate of 40 cc per minute. The detector current was adjusted to 170 mV. The

following is an outline of the operating procedure for analyzing the gas samples.

- (1) The sample tube was attached to the extraction system and Ar carrier gas passed through the molecular sieve column into the gas chromatographic system.
- (2) The main stopcock of the tube was opened and the pressure of the permanent gases measured.
- (3) H<sub>2</sub> and He were determined with the molecular sieve column at -78° C and Ar carrier gas.
- (4) The carrier gas was changed to He and the polarity switch shifted accordingly. The detector control current was adjusted to 25 milliamperes.
- (5) Ar and O<sub>2</sub> were analyzed with the molecular sieve column kept in the dry ice and acetone Dewar trap (-78° C).
- (6) At room temperature the rest of the permanent gases (O<sub>2</sub>, N<sub>2</sub>, CH<sub>4</sub>, CO) was separated on the molecular sieve column with He as the carrier gas.
- (7) The permanent gases were pumped out of the system.

(8) The condensable gases were transferred from the trap (D) to the cold finger (F), and expanded in the measuring system and into the expansion bulb (G) if needed.

(9) The pressure of the condensable gases were measured.

(10) The silica gel column determined the condensable gases (mostly air and  $\text{CO}_2$ ) with He carrier gas at  $100^\circ \text{C}$ .

(11) The free volume of the sample tube was determined.

(12) The stopcock of the sample tube was closed, and the tube transferred from the system to a  $\text{CO}_2$  measurement system shown in Figure 4.

(13) The  $\text{CO}_2$  measurement system was pumped out.

(14) A small hole was made on the sample tube by glass blowing.

(15) The Mallcosorb in the tube was dissolved in 6F HCl.

(16) The stopcock of the tube was carefully opened so that the released  $\text{CO}_2$  could be transferred into the liquid  $\text{N}_2$  trap (e).

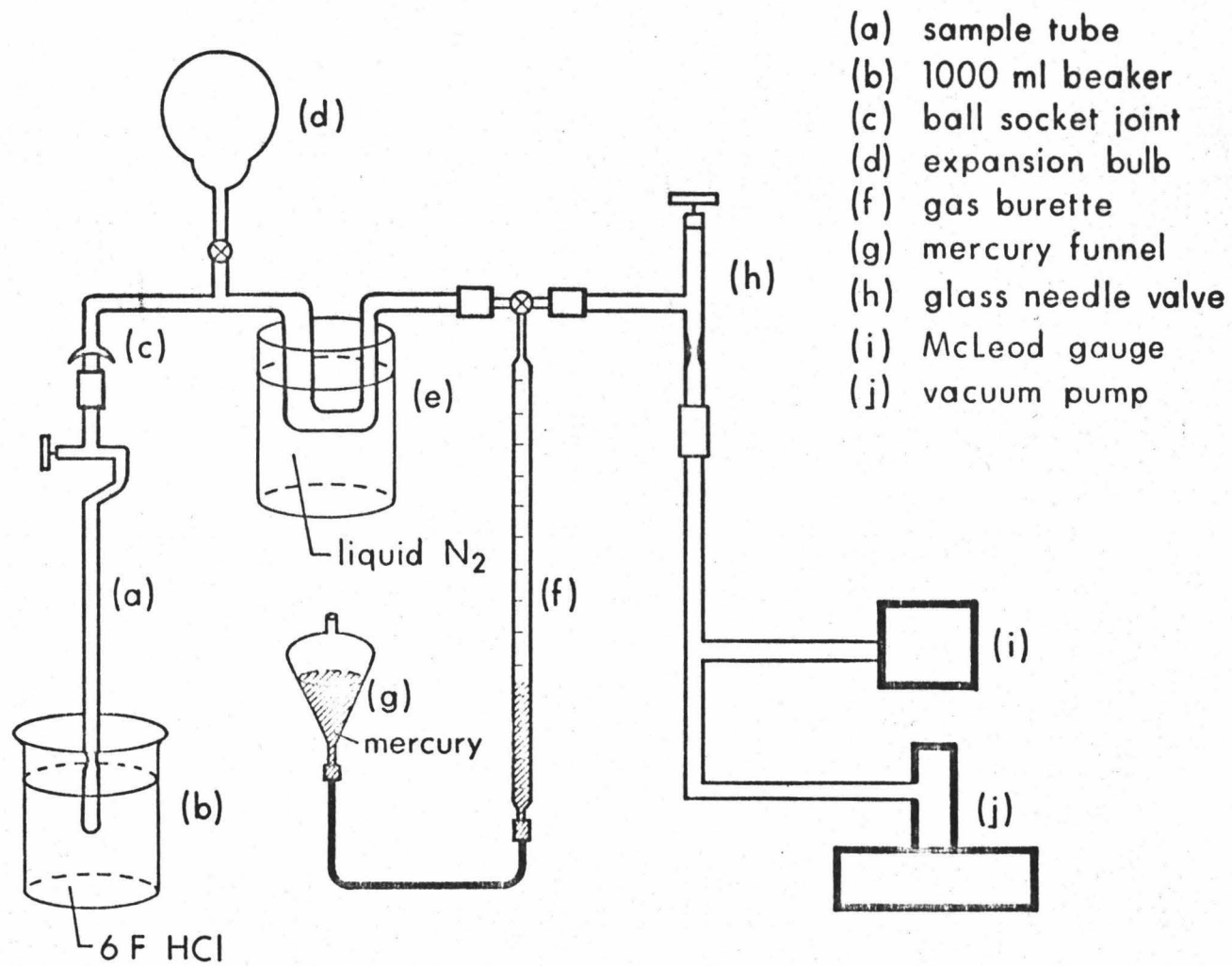

Figure 4. Extraction and Measurement System for CO<sub>2</sub>

(17) The  $\text{CO}_2$  was expanded into the gas burette (f) and the expansion bulb (d).

(18) The pressure was measured, and the volume of  $\text{CO}_2$  at STP determined accordingly.

TABLE II

## PARAMETERS OF THE GAS CHROMATOGRAPHIC SYSTEM

Gas	Retention time (minutes)	Column Parameters	Thermal Conductivity* cal./cm.sec./deg. (0° C)	Carrier gas
He	2.2	Molecular sieve 5A, at -78° C	33.60	Ar 40 cc/min.
H <sub>2</sub>	3.5		39.60	
Ar	18.7	Molecular sieve 5A, at -78° C	3.88	He 40 cc/min.
O <sub>2</sub>	26.3		5.70	
H <sub>2</sub>	0.9	Molecular sieve 5A, at room temperature	39.60	He 40 cc/min.
O <sub>2</sub>	1.3		5.70	
N <sub>2</sub>	3.0		5.68	
CH <sub>4</sub>	4.8		7.20	
CO	13.5		5.43	
Air	0.9	Silica gel at 100° C	7.50 at 100° C	He 40 cc/min.
CO <sub>2</sub>	1.8		3.39	
H <sub>2</sub> S	4.9		3.05	
SO <sub>2</sub>	20.5		1.95	

\* abstracted from Jeffery and Kipping<sup>33</sup>



### III. RESULTS AND DISCUSSION

#### A. Introduction

The results of analyzing gas samples from the Sulfur Bank fumarole are summarized in Tables III and IV. The experimental data have been re-calculated by subtracting all  $O_2$  and  $N_2$ , as well as corresponding amounts of the other atmospheric gases ( $CO_2$ , Ar, He and  $H_2$ ) based on the amount of  $N_2$  found and their  $N_2$  ratios in "sea level atmospheric air."<sup>34</sup> These are shown in the form of mole percentage, along with the various mole percentage ratios between the components. Table IV includes the mole percentage of air in each sample, which was determined by adding up the portions of gas subtracted to make the air free corrections. It is very significant to calculate the percentage of air contamination in the sample in that this provides a simple criterion for evaluating the quality of the gas sample and the collecting technique. The condensable gases, which are not shown in the table, were added to the total moles since the primary interest in this investigation was to observe the variations in hydrogen and helium in terms of the eruption cycle.

## B. Evaluation of Experimental Technique

### 1. Evaluation of the samples

Reference to Tables III and IV in which are presented the analyses of the collected fumarole gases in terms of mole and mole percentage, shows that there has been a continual measurement of helium and hydrogen in the samples. However, a divergence has been observed in the calculated results with the samples collected on the same date, which were expected to come out in closer agreement.

In order to understand this poor precision, it is necessary to consider some of the difficulties entailed in getting the samples. It is almost impossible to obtain a sample without some mixing with air at the time of collection, partly because of the environment of the sampling sites that are always surrounded by an ocean of air and partly because of the imperfect sampling devices and techniques employed. It also seems to be nearly certain that the air filters down through the porous rocks surrounding the sampling sites and mixes with the volcanic gases inside before collection.

TABLE III  
ANALYSES OF SULFUR BANK SAMPLES

(Units in Moles)

Sample No. & Date	H <sub>2</sub> O	He x10 <sup>7</sup>	H <sub>2</sub> x10 <sup>7</sup>	Ar x10 <sup>5</sup>	O <sub>2</sub> x10 <sup>5</sup>	N <sub>2</sub> x10 <sup>5</sup>	Cond. Gases (CO <sub>2</sub> ,SO <sub>2</sub> ,H <sub>2</sub> S)	Total Moles
8 1/11/70	0.608	10.50±2.10	6.80±1.30	0.2820±0.0120	0.455±0.019	63.10±1.50	0.040±0.001	0.648±0.001
10 1/25/70	0.194	3.36±0.64	1.99±0.38		1.960±0.370	18.70±0.40	0.013±0.0003	0.207±0.000
12 2/08/70	0.047	1.63±0.31	4.88±0.93	1.1000±0.0300	1.790±0.800	65.50±1.60	(2.150±0.05) x10 <sup>-3</sup>	0.050±0.000
15 2/21/70	0.066	3.90±0.74	3.17±0.61		1.380±0.260	8.80±0.38	(4.000±0.09) x10 <sup>-3</sup>	0.070±0.000
17 3/14/70	0.364	6.75±0.84	6.46±0.03	0.1190±0.0150	0.805±0.035	34.60±0.80	0.030±0.0007	0.394±0.001
20 4/01/70	0.503	6.35±1.22	58.40±1.25		0.254±0.032	17.20±0.40	0.034±0.0007	0.537±0.001
21 4/01/70	0.340	2.85±0.55	3.58±0.45		1.620±0.200	46.50±1.10	0.024±0.0007	0.364±0.001
25 5/09/70	0.465	7.95±0.10	3.92±0.49		0.377±0.047	12.80±0.30	0.030±0.0007	0.495±0.001
24 6/11/70	0.435	7.60±0.95	5.13±0.64		0.815±0.102	38.60±0.90	0.030±0.0007	0.465±0.001
28 6/11/70	0.425	7.85±0.98	5.12±0.64		0.292±0.036	13.20±0.30	0.028±0.0007	0.453±0.001
33 6/30/70	0.458	11.40±0.50	4.12±0.52		0.310±0.049	13.90±0.30	0.031±0.0007	0.489±0.001
34 6/30/70	0.390	6.40±1.23	6.25±0.78	0.0112±0.0003	9.630±0.410	88.50±0.41	0.016±0.0004	0.416±0.001
35 7/16/70	0.099	1.62±0.31	1.30±0.25	1.6000±0.0400	3.140±0.140	7.65±0.32	0.011±0.0003	0.110±0.000

TABLE III (Continued)  
ANALYSES OF SULFUR BANK SAMPLES

Sample No. & Date	H <sub>2</sub> O	He x10 <sup>7</sup>	H <sub>2</sub> x10 <sup>7</sup>	Ar x10 <sup>5</sup>	O <sub>2</sub> x10 <sup>5</sup>	N <sub>2</sub> x10 <sup>5</sup>	Cond. Gases (CO <sub>2</sub> , SO <sub>2</sub> , H <sub>2</sub> S)	Total Moles
36 7/16/70	0.288	4.15±0.80	3.20±0.40	0.8150±0.0200	7.600±0.330	6.20±0.15	0.200±0.0005	0.308±0.001
31 8/18/70	0.514	4.20±0.81	3.84±0.48		0.198±0.038	6.95±0.30	0.035±0.0008	0.549±0.001
39 8/24/70	0.137	1.79±0.34	1.16±0.22	1.4600±0.0400	0.625±0.027	6.00±0.14	(9.000±0.22) x10 <sup>-3</sup>	0.146±0.000
29 9/26/70	0.577	4.55±0.57	2.48±0.48		20.000±2.500	1.10±0.05	0.390±0.0009	0.616±0.001
30 9/26/70	0.552	3.66±0.71	5.70±0.71		0.840±0.036	27.00±0.60	0.033±0.0008	0.588±0.001
42 10/10/70	0.262	2.30±0.44	1.28±0.25		14.400±0.600	5.65±0.35	0.026±0.0006	0.288±0.001
37 10/24/70	0.157	1.67±0.32	1.24±0.24		0.294±0.057	7.34±0.02	0.013±0.0003	0.714±0.000
46 11/7/70	0.222	1.31±0.25	1.06±0.21	0.0346±0.0066	2.140±0.090	18.20±0.80	0.021±0.0005	0.243±0.001
44 11/22/70	0.332	2.09±0.40	2.55±0.49		0.505±0.097	14.10±0.30	(2.000±0.05) x10 <sup>-3</sup>	0.334±0.000
47 12/6/70	0.115	1.02±0.19	1.22±0.23		8.400±0.360	24.80±0.60	(9.000±0.22) x10 <sup>-3</sup>	0.124±0.000
50 12/19/70	0.129	1.16±0.22	1.22±0.23		0.268±0.033	1.63±0.04	(9.000±0.22) x10 <sup>-3</sup>	0.138±0.000
51 12/29/70	0.209	1.84±0.35	1.87±0.36		0.607±0.021	3.64±0.09	0.021±0.0009	0.230±0.000
22*	6.65x10 <sup>-3</sup>	1.38±0.17	20.80±0.90	3.4600±0.0800	73.000±3.100	197.00±5.00	(4.400±0.16) x10 <sup>-3</sup>	(7.090±0.06) x10 <sup>-3</sup>

\* Collected from the vent of Aloi Crater, Kilauea Volcano

TABLE IV

## MOLE PERCENTS OF THE SAMPLES AFTER AIR CORRECTIONS

(Units in Mole %)

Sample No. Collection Date	H <sub>2</sub> O	He x10 <sup>4</sup>	H <sub>2</sub> x10 <sup>4</sup>	Ar	O <sub>2</sub>	N <sub>2</sub>	Cond. Gases (CO <sub>2</sub> ,SO <sub>2</sub> ,H <sub>2</sub> S)	Air Correction
8 1/11/70	93.83	1.62±0.32	1.05±0.20	(4.40±0.27) x10 <sup>-4</sup>	0.0007	0.0420	6.16±0.15	0.04
	93.87	1.62±0.32	1.05±0.20	(7.00±0.30) x10 <sup>-5</sup>			6.16±0.15	
10 1/25/70	98.07	1.62±0.31	0.96±0.02		0.0095	0.0900	6.40±0.15	0.10
	98.17	1.62±0.31	0.96±0.02				6.40±0.15	
12 2/08/70	94.00	3.26±0.62	9.70±1.85	(2.20±0.06) x10 <sup>-4</sup>	0.3600	1.4100	4.30±0.01	1.80
	95.80	3.17±0.61	9.61±1.84	(5.00±0.10) x10 <sup>-3</sup>			4.30±0.01	
15 2/21/70	94.27	5.60±1.05	4.40±0.87		0.0200	0.1100	5.70±0.13	0.13
	94.40	5.60±1.05	4.40±0.87					
17 3/14/70	92.38	1.71±0.21	1.64±0.01	(3.02±0.38) x10 <sup>-4</sup>	0.0020	0.0880	7.60±0.18	0.09
	92.47	1.71±0.21	1.64±0.01	(2.75±0.34) x10 <sup>-4</sup>			7.60±0.18	
20 4/01/70	91.80	1.18±0.23	1.08±0.46		0.0005	0.0320	6.35±0.14	0.03
	91.83	1.18±0.23	1.08±0.46				6.35±0.14	
21 4/01/70	93.41	0.80±0.15	0.99±0.12		0.0045	0.1280	6.60±0.14	0.13
	93.54	0.80±0.15	0.99±0.12				6.60±0.14	
25 5/09/70	93.93	1.61±0.02	0.78±0.01		0.0008	0.0260	6.05±0.14	0.03
	93.96	1.61±0.02	0.78±0.01				6.05±0.14	

TABLE IV (Continued)

## MOLE PERCENTS OF THE SAMPLES AFTER AIR CORRECTIONS

Sample No. Collection Date	H <sub>2</sub> O	He x10 <sup>4</sup>	H <sub>2</sub> x10 <sup>4</sup>	Ar	O <sub>2</sub>	N <sub>2</sub>	Cond. Gases (CO <sub>2</sub> , SO <sub>2</sub> , H <sub>2</sub> S)	Air Correction
24 6/11/70	93.54	1.63±0.21	1.10±0.14		0.0018	0.0830	6.45±0.15	0.09
	93.63	1.63±0.21	1.10±0.14				6.45±0.15	
28 6/11/70	93.81	1.73±0.21	1.13±0.14		0.0006	0.0442	6.20±0.15	0.05
	93.86	1.73±0.21	1.13±0.14				6.20±0.15	
33 6/30/70	93.66	2.34±0.10	0.84±0.11		0.0006	0.0286	7.45±0.14	0.03
	93.69	2.34±0.10	0.84±0.11				7.45±0.14	
34 6/30/70	96.15	1.54±0.29	1.50±0.19	(2.70±0.01) x 10 <sup>-4</sup>	0.0230	0.2120	3.86±0.09	0.24
	96.39	1.54±0.29	1.50±0.19				3.86±0.09	
35 7/16/70	90.00	1.47±0.27	1.18±0.25	(1.45±0.04) x 10 <sup>-2</sup>	0.0286	0.0695	10.00±0.27	0.10
	90.10	1.46±0.27	1.18±0.25	(5.20±0.12) x 10 <sup>-4</sup>			10.00±0.27	
36 7/16/70	93.50	1.35±0.26	1.04±0.13	(2.60±0.07) x 10 <sup>-3</sup>	0.0246	0.2000	7.00±0.16	0.23
	93.78	1.34±0.26	1.04±0.13	(6.00±0.14) x 10 <sup>-4</sup>			7.00±0.16	
31 8/18/70	93.62	0.72±0.15	0.70±0.09		0.0004	0.0127	6.27±0.15	0.01
	93.63	0.72±0.15	0.70±0.09				6.27±0.15	
39 8/24/70	93.15	1.23±0.34	0.80±0.15	0.01	0.0041	0.0005	6.15±0.15	0.00
	93.15	1.23±0.34	0.80±0.15	0.01			6.15±0.15	0.00
29 9/26/70	93.66	0.74±0.09	0.40±0.07		0.0030	0.0960	6.34±0.14	0.10
	93.76	0.73±0.09	0.40±0.07				6.34±0.14	

TABLE IV (Continued)

## MOLE PERCENTS OF THE SAMPLES AFTER AIR CORRECTIONS

Sample No. Collection Date	H <sub>2</sub> O	He x10 <sup>4</sup>	H <sub>2</sub> x10 <sup>4</sup>	Ar	O <sub>2</sub>	N <sub>2</sub>	Cond. Gases (CO <sub>2</sub> , SO <sub>2</sub> , H <sub>2</sub> S)	Air Correction
30	93.87	0.62±0.13	0.97±0.13		0.0945	0.0053	5.62±0.13	0.10
9/26/70	93.97	0.62±0.13	0.97±0.13				5.62±0.13	
42	90.98	0.80±0.15	0.45±0.08		0.0500	0.0195	9.05±0.21	0.07
10/10/70	91.05	0.80±0.15	0.45±0.08				9.05±0.21	
37	90.03	0.96±0.18	0.72±0.14		0.0017	0.0420	7.48±0.17	0.04
10/24/70	90.07	0.96±0.18	0.72±0.14				7.48±0.17	
46	91.50	0.54±0.10	0.44±0.09	(1.41±0.29) x 10 <sup>-4</sup>	0.0088	0.0770	8.75±0.21	0.09
11/07/70	91.59	0.54±0.10	0.43±0.09				8.75±0.21	
44	99.40	0.63±0.12	0.77±0.14		0.0015	0.0422	0.60±0.01	0.04
11/22/70	99.44	0.63±0.12	0.77±0.14				0.60±0.01	
47	93.55	0.82±0.15	0.82±0.18		0.0677	0.2000	7.25±0.18	0.30
12/06/70	93.85	0.80±0.15	0.82±0.18				7.25±0.18	
50	93.47	0.84±0.16	0.89±0.16		0.0010	0.0120	6.52±0.16	0.02
12/19/70	93.49	0.84±0.16	0.89±0.16				6.52±0.16	
51	90.87	0.80±0.15	0.82±0.16		0.0264	0.1580	9.12±0.39	0.19
12/29/70	91.06	0.80±0.15	0.82±0.16				9.12±0.39	
22*	55.77	1.95x10 <sup>-3</sup>	2.93x10 <sup>-2</sup>	0.487	10.2800	27.7500	6.21	38.03
04/01/70	93.80	1.76x10 <sup>-3</sup>	2.93x10 <sup>-2</sup>	0.134			6.20	

\* Collected from the vent of Aloi Crater, Kilauea Volcano

Oxygen measurements made at Sulfur Bank with an electrochemical oxygen detector show rapid fluctuations, sometimes in the course of a few minutes.<sup>35</sup> These factors show that divergent results are likely.

Therefore, it is not recommended that one should take a series of samples on the same day, then average these to get meaningful results. Some of the samples will be excellent, others very poor. It is preferable to find some means of evaluating samples and to use the better ones in drawing conclusions about the nature of volcanic gases. A possible criterion would be the one that is based on the amount of air contamination in the sample. In the present investigation the better sample of the two collected on the same date has been chosen as the one that has lesser amount of air contamination. Similarly, Jaggar<sup>36</sup> used two criteria, based on the condition of collection and on the composition, to evaluate his samples. Both cases gave some indication of the amount of atmospheric contamination of the gases.

## 2. Evaluation of the sampling tube

The sampling tube used in this research was based on the combination of absorption and vacuum sampling



tube methods as indicated previously. This was a modified design of the sampling tube developed by Naughton et al.<sup>23</sup> The main feature of the design was the construction of a free volume which could collect a large amount of the residual permanent gases including H<sub>2</sub> and He, and the inclusion of two kinds of absorbent, Aquasorb and Mallcosorb, for preventing interactions among the gases, thus preserving the composition of the sample gas. Assuming these absorbents prevented the reactions among the gases, the samples can be evaluated by the amount of air contamination.

The possibilities of air contamination have been discussed by Finlayson.<sup>26</sup> The one possibility, according to him, is that the sample is accidentally contaminated by atmospheric air surrounding the sampling site. In this case, contamination by air would occur during sampling, and it would depend on the collecting tube and technique used, and the conditions at the sampling site. In the present study, all the samples were collected from a small piped hole at the Sulfur Bank. There seemed to be little chance for air mixing with the sample gases in this way. Actually, the samples

were found to have little air contamination as is shown in Table IV. The air contamination ranged from 0 to 1.80 percent. However, considerable air was found in one sample (No. 22) which was taken by using the same collection tube and technique from the new vent near Aloi Crater located on the flank of Kilauea Caldera. This was not unexpected because of the unfavorable sampling conditions at the sampling site and the radiation of intense heat from the crater. Another explanation as to why the large amount of air contamination was observed might be that the sampling tube was originally designed to collect gas samples from an enclosed or drilled hole such as the one at Sulfur Bank fumarole. The other possibility for air contamination is that the volcanic gases are mixed with air by the natural infiltration through the porous rocks of the shield of the volcano. Thus, it is almost impossible to collect the volcanic gases without any contamination by air. Therefore, samples containing the least amount of air should be the best ones. The gas samples collected in the present work were excellent in this regard, since the air contamination was surprisingly low.

TABLE V

PRECISION AND ACCURACY OF THE GAS ANALYSIS SYSTEM  
(Seven Runs of Philips Gas Mixture G-7)

Gas Component	Mole %	R* (Range)	S** (Standard Deviation)	Philips Analysis of G-7 Mole %	Philips Deviation Mole %	Philips Deviation Mole % <i>from</i>
N <sub>2</sub>	<sup>6</sup> 59.64	1.20	0.45	67.91	0.5	1.73
H <sub>2</sub>	8.21	0.79	0.29	11.23	0.2	3.02
CO <sub>2</sub>	4.55	0.31	0.12	4.82	0.2	0.27
CO	17.32	1.79	<u>0.66</u> <i>4.152</i>	14.52	0.2	2.80
Ar	0.31 <i>100.03</i>	0.124	<u>0.05</u>	0.94	0.1	0.63 <i>54.45</i> <i>1.69</i>

\* R: A spread between the highest and lowest values of the Mole %.

\*\* S = R x K<sub>M</sub>, where K<sub>M</sub> represents a multiplication factor based on the number of observations, for seven observations, K<sub>M</sub> = 0.37.<sup>33</sup>

### 3. Source of errors in analysis

Errors associated with gas chromatographic technique and particularly with its application to the study of volcanic gases have been discussed by Heald<sup>37</sup> and by Finlayson.<sup>26</sup>

The inaccuracy in measuring the peak area of the chromatogram is believed to be one of the most important sources of error. The peak area for a particular component will depend on its concentration in the sample and the detector's sensitivity to it. Therefore, with the same detector the peak area produced by gas component will decrease directly as its concentration decreases. According to Janak's statistical survey of methods of integration,<sup>40</sup> approximation of the peak to a triangle and area measurement by multiplying the height by the width at half-height, the method used in this work, was comparable to most other manual methods. Janak found the mean standard deviation for peaks smaller than  $0.5 \text{ Cm}^2$  to be 19.2%, for peaks between  $0.5$  and  $1.0 \text{ Cm}^2$ , 12.5%, for peaks between  $1.0 \text{ Cm}^2$  and  $3.0 \text{ Cm}^2$ , 4.3%, and for peaks between  $3.0 \text{ Cm}^2$  and  $12.0 \text{ Cm}^2$ , 2.4%. This indicates that precision of the results

decreases as the peak areas decrease. This source of error is particularly important in samples which contain small amounts of gas components contaminated by large amounts of air, as is almost always the case in collecting volcanic gases. Fortunately, this error was somewhat minimized in this investigation due to the relatively lesser contamination by air (see the sample calculation in Appendix I, and the upper and lower limits indicated by vertical bars in Figure 5) and the use of the sampling tube with large free volume which could collect large amounts of gas components. The effects of these deviations have been carried through the calculations, and are shown as the standard deviations in Table IV (See also Appendix I).

Another source of error was the instrumental errors inherent in the gas chromatograph. These errors include non-linearity of the detector response, variations in the flow rate and in the temperatures of the columns and detectors. An abnormal drift of the recorder pen due to a sudden change of air convection currents and the effect of this on the detector would be an example of a temperature effect.

These errors can be made minor in comparison to the peak measurement errors mentioned above. By maintaining constant flow rate and temperature from sample to sample, and keeping the sample size within the linearity range of the detector, these errors were kept to a minimum. Precision and accuracy of the gas analyzing system measured with a standard gas mixture (Philips gas mixture G-7) are shown in Table V.

#### C. Interpretation of the results

The following is a discussion of the analytical results on fumarolic gases from the Sulfur Bank located on the east rim of Kilauea Caldera, Hawaii. The results of the gas analyses are presented in Tables III and IV. Sulfur Bank, as evidenced by its situation on one of the rim faults of Kilauea Caldera, may be closely associated with the main magma chamber of Kilauea volcano. For this reason the Sulfur Bank has long been a prime source of gases. Since the first samples collected from the piped wells at this fumarole,<sup>13</sup> it has been suspected that a constant and thorough study of these gases would enable prediction of approaching eruptions. Ballard and Payne<sup>17</sup> observed the variations of gas

composition, particularly  $\text{SO}_2$ , in relation to the volcanic eruption. In 1963, Heald et al.<sup>39</sup> presented data indicating that  $\text{H}_2\text{S}$  was very significant in that respect, increasing significantly before eruptions that occurred during their investigation. In the study on fumarolic gases collected at the Sulfur Bank, Finlayson<sup>26</sup> detected helium in a series of samples, and the concentration of  $\text{H}_2$  and He seemed to increase significantly before the eruptions. Since then attention has been focused on changes in the composition of these two gases in terms of the volcanic cycle.

The data of the present work have been examined for this effect. The changes of the mole percentage concentration of  $\text{H}_2$  and He found with time are shown in Figure 5, and also the time periods for the flank eruptions from Kilauea volcano that occurred during the investigation. Included in Figure 6 are the mole ratios of  $\text{H}_2$  and  $\text{H}_2$  to  $\text{H}_2\text{O}$  with respect to time, which is particularly significant for  $\text{H}_2$ , since it probably is derived from the thermal dissociation of water at the hot source in the magma chamber. Eruption has been continuous since July 1970. The time periods for eruption together with the tilt measurements in microradians recorded at the tiltmeter are

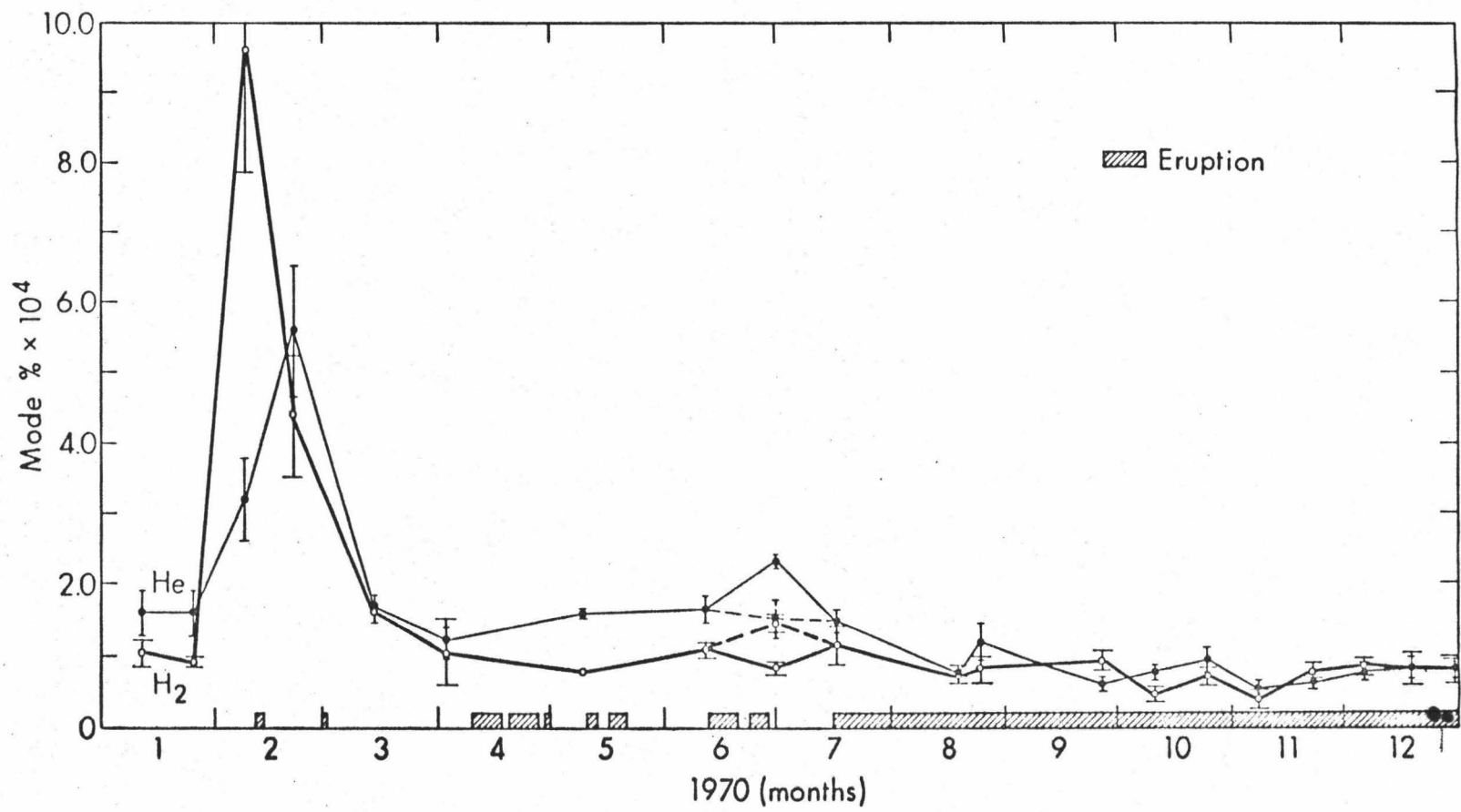

Figure 5. H<sub>2</sub> and He Variations with Time at the Sulfur Bank Fumarole



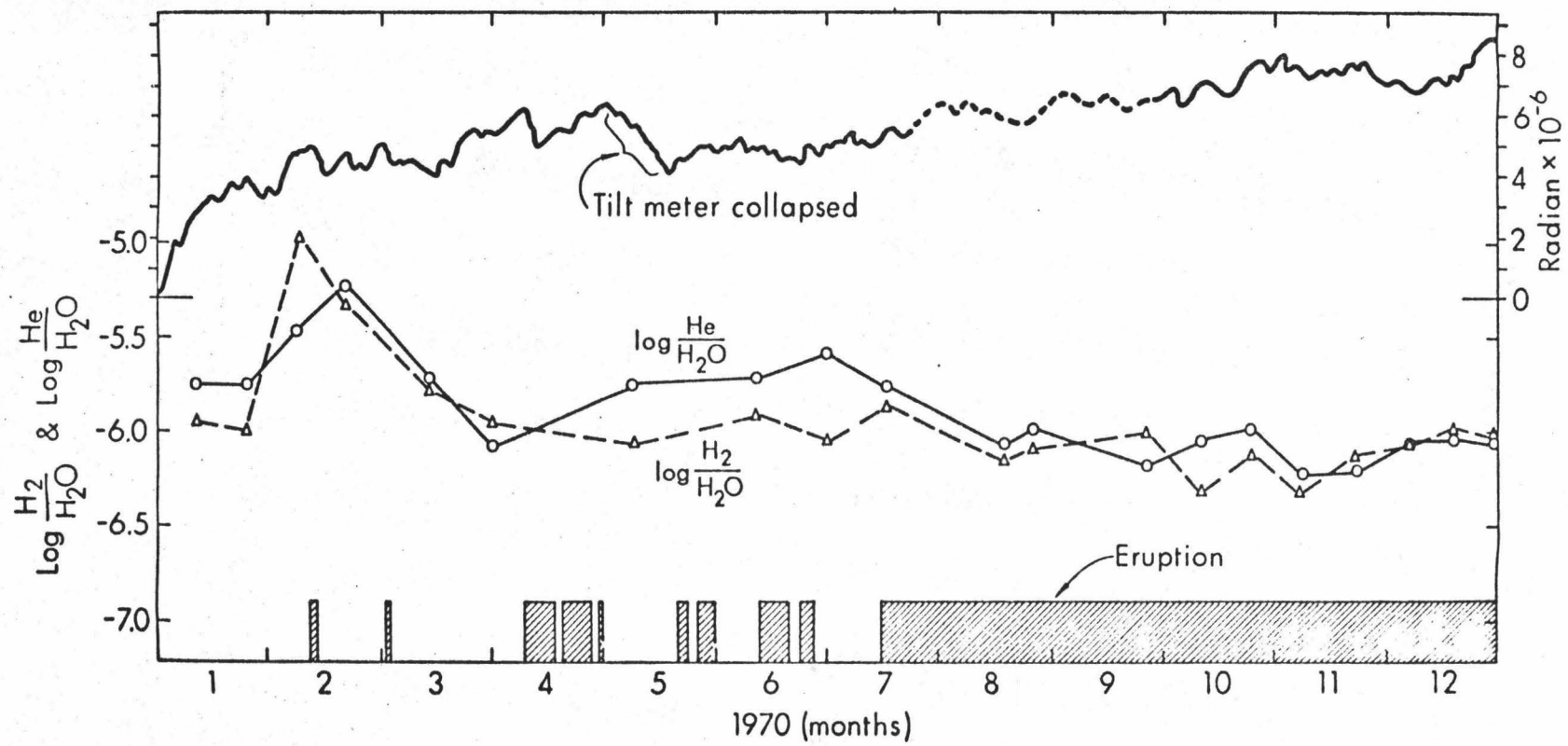

Figure 6. Mole Ratios of H<sub>2</sub> and He to H<sub>2</sub>O with Time at the Sulfur Bank Fumarole

also plotted in Figure 6. The tiltmeter is located in the Volcano Observatory area on the summit of Kilauea Caldera. The tilt measurements recorded with time show changes in elevation and tilting of ground at the summit of the volcano, which are associated with the movements of magma beneath the volcano.

It is evident that the variations in  $H_2$  and He concentration with time are associated to some degree with the volcano activities at Kilauea. In January 1970, when the Kilauea volcano had been only intermittently active for some time with eruptions of a few hours' duration, the gas samples contained very small amounts of hydrogen and helium. However, there was a sharp increase in these gases measured in February, just before the activity started to be of longer duration, and finally became continuous (July). The increased amounts of  $H_2$  and He at this time were  $9.6 \times 10^{-4}$  and  $3.2 \times 10^{-4}$  mole percent, respectively, which were remarkably high in comparison with the other values measured during the investigation (generally less than  $2 \times 10^{-4}$  mole percent). They showed a return to their previous low values even before the eruption had settled down to a steady activity in March.  $H_2$  and He in the samples obtained during

the period of continuous eruption seemed to approach nearly constant values (about  $1.5 \times 10^{-4}$  mole percent for  $H_2$ , and about  $1.4 \times 10^{-4}$  mole percent for He), whereas the tiltmeter showed a continuous increase in ground elevation at the summit.

Thus the time of an approaching eruption may be predicted by measuring the variations in composition of these two gases. For repeat samples taken at the same time, there were sometimes unexpected fluctuations observed for the measured amounts of the individual gases. These fluctuations may have resulted from the failure of sample collection at that particular time, or due to actual fluctuation in the concentrations of the components. An example of such fluctuation is shown in Figure 5, where two good samples were collected on June 30, 1970 (Samples, Nos. 33 and 34), and yet had a significantly different content of hydrogen and helium, outside the range of the standard deviation.

It seems that, in general, gases emanating from the volcano increase before the eruption and decrease with pressure released after the eruption starts. This phenomenon has also been observed for haloids and sulfur gases by several investigators.<sup>7, 8, 26</sup> The range in ground elevation

at the summit of the volcano seems to be independent of the change in gas components of the samples. Therefore it can be concluded that the composition of gases issuing from the volcano may be more sensitive to the volcanic activity than the tilt measurement recorded at the summit.

A mechanism capable of explaining the variation of gas composition in relation to the eruption can be postulated by considering the relationship of a persistent fumarole to the magma chamber underneath the volcano. As the gases are released from the magmatic source, they percolate upward, diffusing through the heated rocks of the earth's crust into a porous region such as the fumarole at Sulfur Bank. Just before the eruption takes place, the gases escape from the magma chamber at increased rate due to the pressure build-up therein. Hence, large amounts of these volcanic gases will reach the surface at this time. After the eruption has started, however, the escaping rate of the gases is slowed down due probably to the pressure release. The percentage of the primary diffusing gases in the total gas mixture collected at this time would be small. Hydrogen and helium, in particular, would respond quickly according to the proposed mechanism, since they are small molecules which diffuse

through heated silicates at a very high rate. Hydrogen would be present due to dissociation of water at the high temperatures of the magma, as indicated previously, and helium would accumulate in the magma chamber from the decay of radioactive elements such as uranium and thorium which are present in rocks deep in the earth.

There was no volcanic activity at Mauna Loa in the course of the present investigation. Therefore, the validity of this conclusion regarding the volcano Mauna Loa should be checked by further observations.

#### IV. CONCLUSION

The following conclusions are reached from the results of the research on fumarolic gases presented in this thesis:

A. Regarding the experimental techniques employed for collection and analysis of the gas samples

1. The Aquasorb-Mallcosorb packed sampling tube was found to be excellent for collecting gas samples at the Sulfur Bank, since air contamination was minimized.
2. Compositional variations in gas analyses were observed even in the samples collected on the same date, indicative of rapid changes.
3. The variations in concentration of hydrogen and helium in the gas sample give good promise of usefulness in the prediction of volcanic eruptions in advance of their onset.
4. Sampling about once a week is of sufficient frequency to determine the changes in gas composition in relation to the eruption cycle.
5. It is suggested that daily measurements of the concentration of hydrogen and helium would be even more desirable in observing the changes in these two gases with respect to time.

B. With regard to the gas analyzing system

1. Gas chromatography is a satisfactory technique for the analysis of volcanic gases because of its relatively high sensitivity and adaptability.
2. A precision quartz bourdon tube pressure gauge is an excellent improvement in convenience and accuracy over the mercury manometer generally used for measuring gas pressure in the analysis system.
3. The largest errors in the gas chromatographic analysis of volcanic gases result in the main part from the measurement of small peak areas and small pressures.
4. The absorption sampling system for the condensable gases is useful only for  $\text{CO}_2$ , but  $\text{SO}_2$  and  $\text{H}_2\text{S}$  are irreversibly retained. These sulfur gases frequently appear in fumarolic gases.

## V. SUMMARY

A study was made of volcanic gases collected at the Sulfur Bank fumarole located on the east rim of Kilauea volcano, Hawaii. The gases were sampled in evacuated, absorbents (Aquasorb-Mallcosorb) containing collection tubes having a large free volume. Gas analysis was carried out by means of gas-solid absorption chromatography, using molecular sieve 5A and silica gel columns to separate the gases. Carbon dioxide was measured using an extraction system which was newly developed for this research when the CO<sub>2</sub> content was so great that the gas chromatography could not be used. The variations in H<sub>2</sub> and He contents have been discussed in relation to the eruptions which occurred during the investigation in an attempt to observe if the concentration changes of these two gases could be used to predict volcanic eruptions. The results seem to indicate a relationship as far as the volcano Kilauea is concerned. Any relationship with regard to the eruptions of Mauna Loa volcano must be shown by further observations.



## APPENDIX I

## SAMPLE CALCULATION\*

Gas Components	H (in)	W1/2 (in)	A (Cm <sup>2</sup> )	S+ (%)	ATT. (mv)	P** ( ° )	A Total (in <sup>2</sup> )	Mole <sup>1</sup> (Total)	Mole % <sup>2</sup>	Mole % <sup>3</sup> after Air Correction
He	0.42	0.06	0.162	19.2	1	4.509	0.025	1.31+0.25x10 <sup>-7</sup>	5.39+1.03x10 <sup>-5</sup>	5.35+0.12x10 <sup>-5</sup>
H <sub>2</sub>	0.36	0.08	0.186	19.2	1	4.509	0.029	1.06+0.21x10 <sup>-7</sup>	4.35x0.86x10 <sup>-5</sup>	4.30+0.83x10 <sup>-5</sup>
Ar	0.30	0.08	0.155	19.2	5	3.431	0.158	3.46+0.66x10 <sup>-7</sup>	1.41+0.29x10 <sup>-4</sup>	
O <sub>2</sub>	3.46	0.06	1.42	4.3	20	2.731	7.25	2.14+0.09x10 <sup>-5</sup>	8.75+0.37x10 <sup>-3</sup>	
N <sub>2</sub>	5.48	0.08	2.83	4.3	100	2.731	72.5	1.82+0.08x10 <sup>-4</sup>	7.44+0.33x10 <sup>-2</sup>	
CO <sub>2</sub>	0.2 cc	6.92	0.10	4.45	20	0.875	13.84	8.72+0.21x10 <sup>-6</sup>		
	468 cc							2.08+0.05x10 <sup>-2</sup>	8.75+0.21	8.75+0.21
H <sub>2</sub> O								0.222	91.50	91.59+0.08

\* Sample No. 46 has been taken as an example.

\*\* Original pressure reading of the system was 4.849° for the permanent gases, and for CO<sub>2</sub>, 0.964°. Conversion factor for the unit in mmHg = 8.04282 (mmHg/degree).

+ S represents a percent standard deviation which is based on the Janak's statistical results.<sup>40</sup>

## Appendix I - Continued

1. Moles of the permanent gases can be calculated by multiplying calibration data for each gas (see Table I) by the area measured in square inches. The total number of moles of the permanent gases,  $M_p = 2.0 \pm 0.08 \times 10^{-4}$  mole. It was assumed that amounts of  $H_2O$  and  $CO_2$  present in the sample tube give weight gain which, in this case, came out to be 4.912 grams. Thus the weight gain of the sample tube can be used to figure out moles of  $H_2O$  by subtracting amounts of  $CO_2$  measured with the gas chromatograph.

Weight gain of the sample tube = 4.912 gr.

$$\begin{aligned} CO_2 &= \frac{0.917}{3.995} \text{ (468 cc at STP)} \\ H_2O &= 3.995 \text{ gr.} \end{aligned}$$

Therefore, mole  $H_2O = 0.222$ .

Letting  $M_T$  be the total mole of the gases including  $H_2O$ ,  
 $M_T = \text{mole } H_2O + \text{mole } CO_2 + M_p = 0.243 \pm 0.001$

2. The standard deviation of the mole percentage has been calculated by using the following formulas:<sup>41, 42</sup>

$$S_R^2 = (\partial R / \partial x)^2 S_x^2 + (\partial R / \partial y)^2 S_y^2 + (\partial R / \partial z)^2 S_z^2,$$

where  $R = f(x, y, z)$

If, for instance,  $R = y/x$ , the square of the standard deviation of  $R$ ,

$$S_R^2 = (y/x^2)^2 S_x^2 + (1/x)^2 S_y^2$$

For addition and subtraction,

$$S_{x+y}^2 = S_x^2 + S_y^2, \quad S_{x-y}^2 = S_x^2 + S_y^2$$

$$\text{Mole \% He} = \text{He} / M_T \times 100$$

$$\text{He} / M_T = 1.31 \times 10^{-7} / 0.243 = 5.39 \times 10^{-7}$$

$$\begin{aligned} S_{\text{He}} &= \pm 1/0.243 (0.25 \times 10^{-7})^2 (1.31 \times 10^{-7} / 0.243)^2 \\ &\quad \times (10^{-3})^2 = \pm 1.03 \times 10^{-7} \end{aligned}$$

Using  
formula

right answer.

Therefore, mole % He =  $(5.39 \pm 1.03) \times 10^{-5}$

The same way as above was followed for the other components.

3. Air contamination = 0.09% ( $O_2 = 0.009\%$ ,  $N_2 = 0.077\%$ )  
Mole % after air correction:

$$\text{He; } (5.39 \pm 1.03) \times 10^{-5} - (9 \times 10^{-4} \times 5.24 \times 10^{-4}) = (5.35 \pm 1.03) \times 10^{-5}$$

$$\text{H}_2; (4.35 \pm 0.86) \times 10^{-5} - (9 \times 10^{-4} \times 5.0 \times 10^{-5}) = (4.30 \pm 0.86) \times 10^{-5}$$

$$\text{Ar; } (1.41 \pm 0.29) \times 10^{-4} - (9 \times 10^{-4} \times 0.93) = 0$$

$$\text{CO}_2; 8.75 \pm 0.21 - (9 \times 10^{-4} \times 0.03) = 8.75 \pm 0.21$$

$$\text{H}_2\text{O; } 91.50 + 0.09 = 91.59$$

## BIBLIOGRAPHY

1. G. A. Macdonald, "Volcanology," Science, 133, 673-679 (1961).
2. J. P. Eaton and K. J. Murata, "How volcanoes grow," Science, 132, 925-938 (1960).
3. J. Verhoogen, "Temperature within the earth," Am. Scientist, 48, 134-159 (1960).
4. G. A. Macdonald, "Volcanology," Science, 133, 673-679 (1961).
5. C. S. Ross, M. D. Foster, and A. T. Myers, "Origin of dunites and of olivine-rich inclusion in basaltic rocks," Am. Mineralogist, 39, 693-737 (1954).
6. J. B. Finlayson, "A Chemical Study of Hawaiian Volcanic Gases," Ph.D. Dissertation, University of Hawaii, 1967, pp. 44-46.
7. E. M. Heald, "A Chemical Study of Hawaiian Magmatic Gases," Ph.D. Dissertation, University of Hawaii, 1961, pp. 78-85.
8. K. Noguchi and H. Kamiya, "Prediction of volcanic eruption by measuring the chemical composition and amounts of gases," Bull. Volcanologique, 26, 367-378 (1963).
9. L. V. Surnina and L. G. Voronova, "Value of the investigation of the chemical composition of volcanic gases for predicting eruptions," U.S.G.S. Geophys. Abstracts, 221, 513 (1965).
10. J. B. Finlayson, "A Chemical Study of Hawaiian Volcanic Gases," Ph.D. Dissertation, University of Hawaii, 1967, pp. 118-123.
11. A. L. Day and E. S. Shepherd, "Water and volcanic activity," Bull. Geol. Soc. Am., 24, 573-606 (1913).

12. E. S. Shepherd, "The analysis of gases obtained from volcanoes and from rocks," J. Geol., Supplement, 33, 290-370 (1925).
13. E. T. Allen, "Preliminary tests of the gases at Sulfur Banks, Hawaii," Bull. Hawaiian Volcano Observatory, 10, 89-93 (1922).
14. I. L. Grange, "Volcanology, 1927-29, in White Island," N.Z. Dept. Sci. Ind. Res. Bull., 127, 25-31 (1959).
15. C. E. Stehn, "Volcanic phenomena during the months of January and February 1930," Bull. Netherlands East Indian Volcanological Survey, 2, 1-4 (1930).
16. I. Z. Ivanov, "An investigation of the gaseous products of the satellite volcanoes of the Kliuchevskoi Volcano," Bull. Kamchatka Volcanological Station, No. 1, 27-33 (1937).
17. K. N. Phillips, "A chemical study of the fumaroles of Mount Hood," Mazama, 18, 44-46 (1936).
18. S. S. Ballard and J. H. Payne, "A chemical study of Kilauea sulfataric gases, 1938-40," Volcano Letter, No. 469, 1-3 (1940).
19. J. B. Finlayson, "A Chemical Study of Hawaiian Volcanic Gases," Ph.D. Dissertation, University of Hawaii, 1967, pp. 20-22.
20. Y. Mizutani, "Chemical analysis of volcanic gases," J. Earth Sci. Nagoya Univ., 10, 125-134 (1962).
21. T. Sugiura, Y. Mizutani, and S. Oana, "Fluorine, chlorine, bromine, and iodine in volcanic gases," J. Earth Sci., 11, 273-278 (1963).
22. I. Iwasaki, T. Ozawa, M. Yoshida, T. Katsura and M. Kamada, "Chemical analysis of volcanic gases," Bull. Volcanologique, 28, 5-16 (1965).

23. J. J. Naughton, E. F. Heald, and I. L. Barnes, "The Chemistry of Volcanic gases, 1. Collection and analysis of equilibrium mixtures by gas chromatography," J. Geophys. Res., 68, 539-544 (1963).
24. Y. Suwa, "Chemical analysis of volcanic gases by gas chromatography," J. Earth Sci., Nagoya Univ., 13, 12-22 (1965).
25. B. D. Gunter and B. C. Musgrave, "Gas chromatographic measurements of hydrothermal emanations at Yellowstone National Park," Geochim. et Cosmochim. Acta, 30, 1175-1189 (1966).
26. J. B. Finlayson, "A Chemical Study of Hawaiian Volcanic Gases," Ph.D. Dissertation, University of Hawaii, 1967.
27. T. A. Jaggar, "The borings at Kilauea volcano," Monthly Weather Rev., 52, 146-147 (1924).
28. E. T. Allen and E. G. Zies, "A chemical study of the fumaroles of the Katami Region," Natl. Geog. Soc. Papers, Katami Ser., No. 2, 75-155 (1923).
29. N. Brenner and R. J. Olson, "Basic knowledge of gas chromatography and gas chromatographic instruments," The Practice of Gas Chromatography, Interscience, New York, 1967, pp. 1-69.
30. E. W. Lard and R. C. Horn, "Separation and determination of argon, oxygen, and nitrogen by gas chromatography," Anal. Chem., 32, 878-879 (1960).
31. D. P. Manka, "Complete gas chromatographic analysis of fixed gases," Anal. Chem., 36, 480-482 (1964).
32. C. T. Hodges and R. F. Matson, "Gas chromatographic separation of CO<sub>2</sub>, COS, H<sub>2</sub>S, CS<sub>2</sub>, and SO<sub>2</sub>," Anal. Chem., 37, 1065-1066 (1965).
33. P. G. Jeffery and P. J. Kipping, "Gas Analysis by Gas Chromatography," Pergamon Press, New York, 1964, pp. 9-14.

34. R. C. Weast, ed., "Handbook of Chemistry and Physics," Chemical Rubber Co., 50th edition, 1969-1970, p. F 151.
35. J. J. Naughton, Private communication.
36. T. A. Jaggar, "Magmatic gases," Am. J. Sci., 238, 313-353 (1940).
37. E. M. Heald, "A Chemical Study of Hawaiian Magmatic Gases," Ph.D. Dissertation, University of Hawaii, 1961, pp. 59-60.
38. D. A. Skoog and D. M. West, "Fundamentals of Analytical Chemistry," Holt, Rinehart and Winston, New York, 1966, Chap. 1.
39. E. F. Heald, J. J. Naughton, and I. L. Barnes, "The chemistry of volcanic gases, 2. Use of equilibrium calculations in the interpretation of volcanic gas samples," J. Geophys. Res., 68, 545-557 (1963).
40. J. Janak, "Statistische Auswertung der Messmethoden zur Quantitativen Bearbeitung von Registrierten Differentialkurven in der Gas-Chromatographie," J. Chromatog., 3, 308-312 (1960).
41. H. A. Strobel, "Chemical Instrumentation," Addison-Wesley, Reading, Mass., 1960, Chapter 2.
42. W. G. Cochran, "Statistical Methods," Iowa State University Press, Ames, Iowa, 1968, Chapter 4.